

Melbourne  
Architectural

MILLWORK COMPANY

## PROFILE CATALOG

BASE PROFILES pgs A1-A35

CASING PROFILES pgs B1-B38

CROWN PROFILES pgs C1-C38

MISC PROFILES pgs D1-D14

TRIM PROFILES pgs E1-E26

RAIL PROFILES pgs F1-F9

325 East Drive - Melbourne, FL 32904

321-308-3297 - Fax 321-308-3299

[WWW.MAMILLWORK.COM](http://WWW.MAMILLWORK.COM)

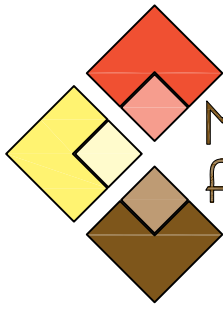

Melbourne  
Architectural  
MILLWORK COMPANY

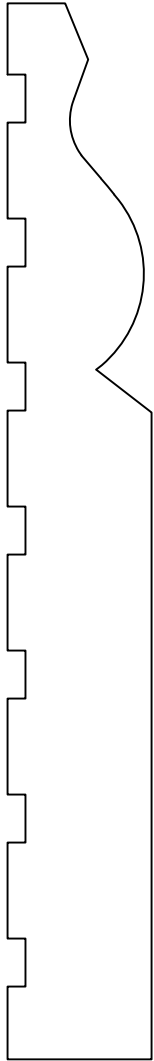

BASE002  
3/4" X 5 1/2"

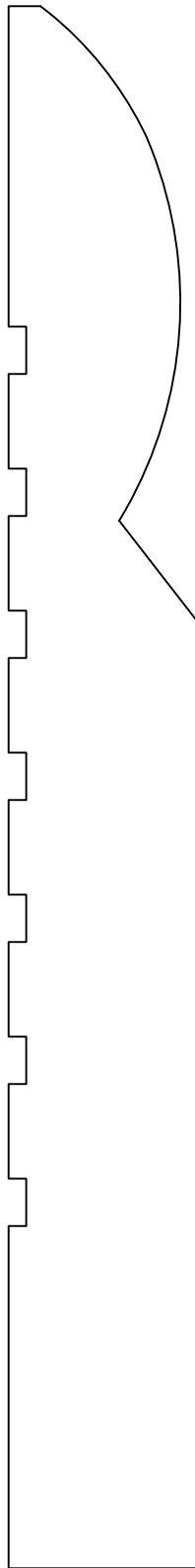

BASE001  
1" X 8 1/4"

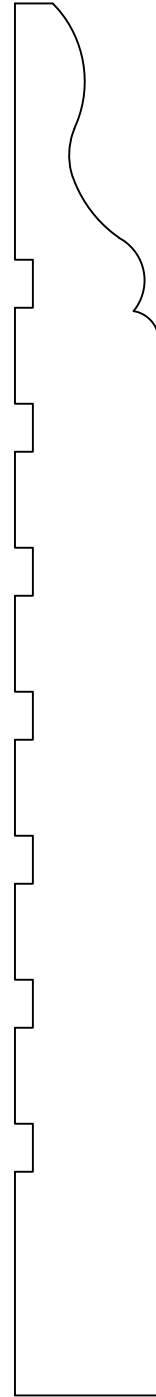

BASE003  
3/4" X 7 1/4"

325 East Drive - Melbourne, FL 32904  
321-308-3297 - Fax 321-308-3299

A01

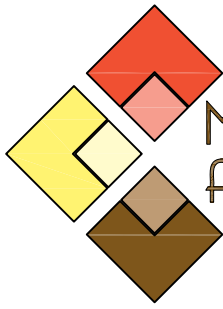

Melbourne  
Architectural  
MILLWORK COMPANY

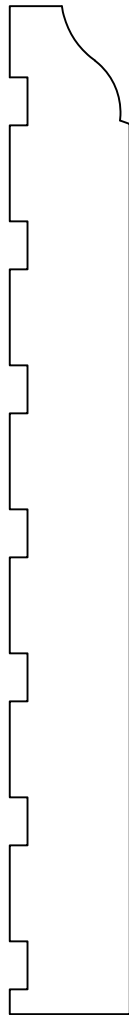

BASE004  
5/8" X 5 1/4"

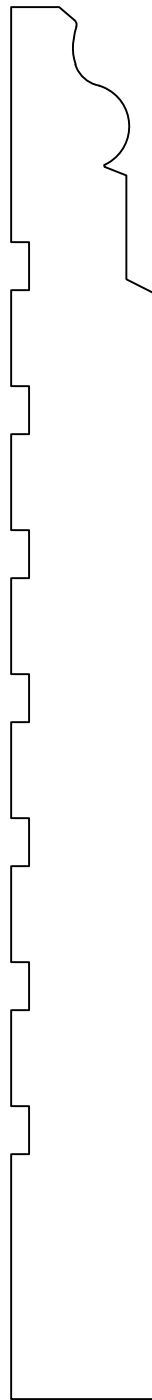

BASE005  
3/4" X 7 1/4"

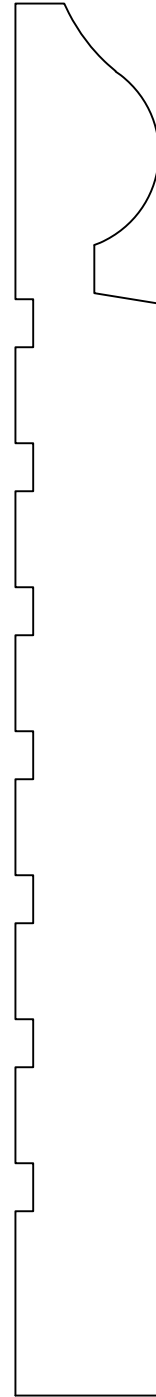

BASE006  
3/4" X 7 1/4"

A02

325 East Drive - Melbourne, FL 32904  
321-308-3297 - Fax 321-308-3299

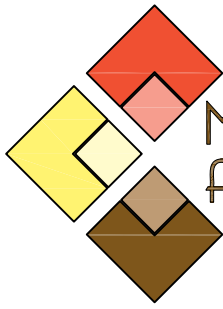

Melbourne  
Architectural  
MILLWORK COMPANY

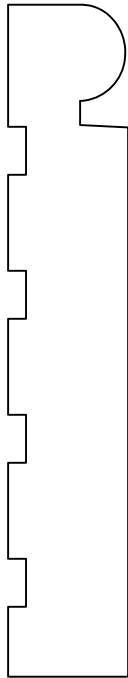

BASE009  
5/8" X 3 1/2"

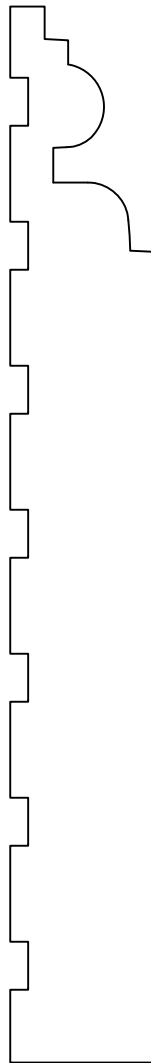

BASE008  
3/4" X 5 1/2"

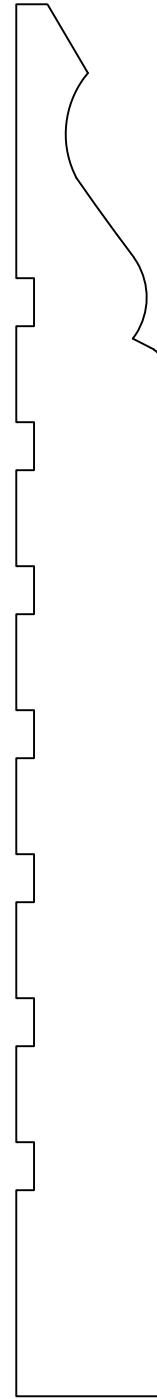

BASE007  
3/4" X 7 1/4"



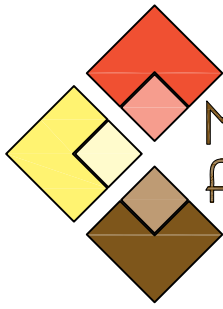

Melbourne  
Architectural  
MILLWORK COMPANY

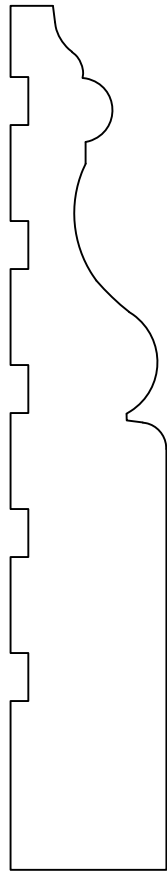

BASE011  
13/16" X 4 1/2"

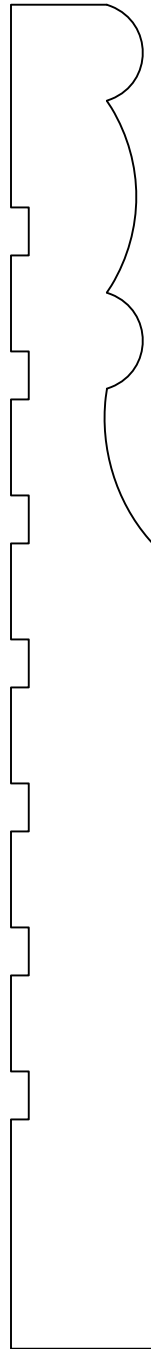

BASE010  
3/4" X 7"

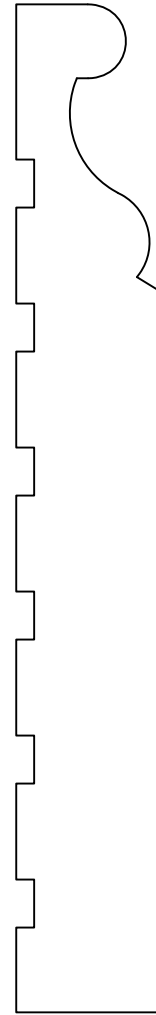

BASE012  
3/4" X 5 1/4"

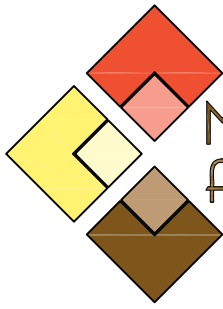

Melbourne  
Architectural  
MILLWORK COMPANY

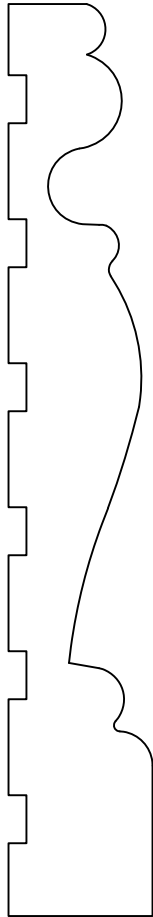

BASE015  
3/4" X 4 3/4"

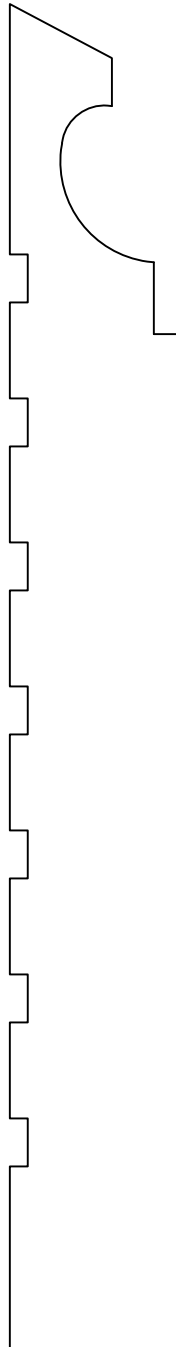

BASE014  
7/8" X 7"

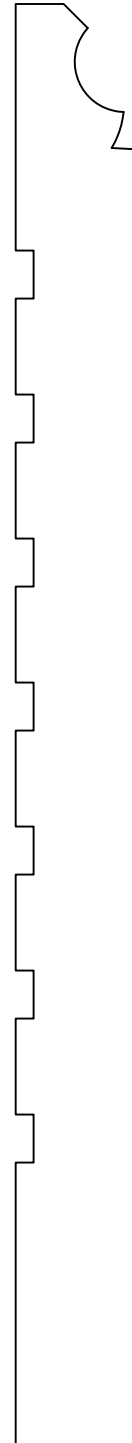

BASE013  
5/8" X 7 1/2"

325 East Drive - Melbourne, FL 32904  
321-308-3297 - Fax 321-308-3299

A05

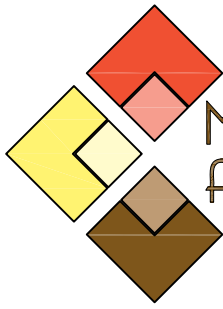

Melbourne  
Architectural  
MILLWORK COMPANY

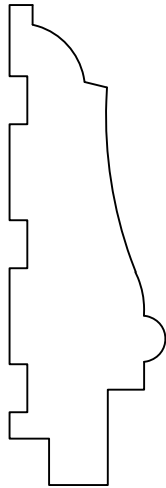

BASE016  
13/16" X 2 1/2"

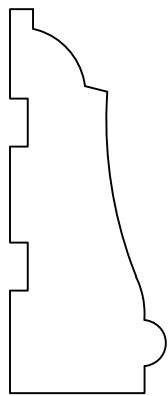

BASE017  
13/16" X 2"

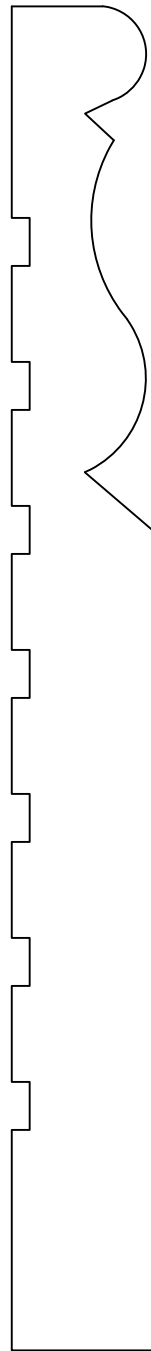

BASE018  
3/4" X 7"

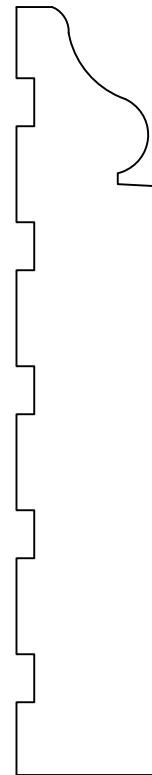

BASE019  
3/4" X 4"

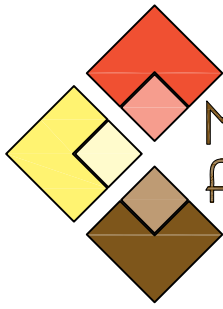

Melbourne  
Architectural  
MILLWORK COMPANY

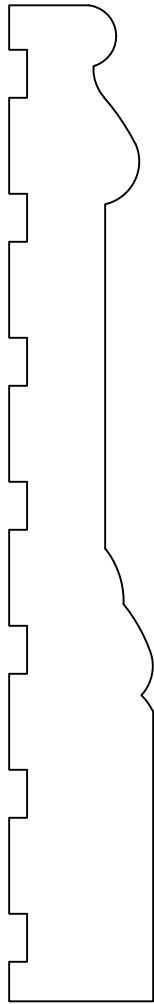

BASE020  
3/4" X 5 3/16"

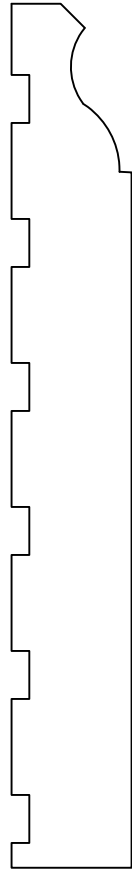

BASE021  
5/8" X 4 1/2"

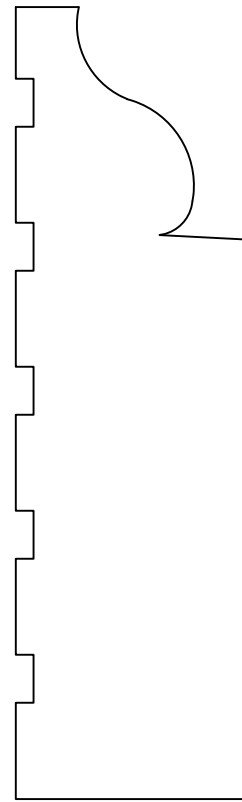

BASE022  
1 3/16" X 4 1/8"

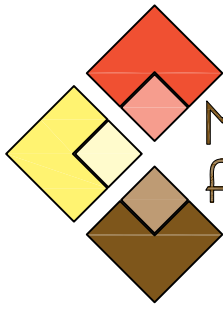

Melbourne  
Architectural  
MILLWORK COMPANY

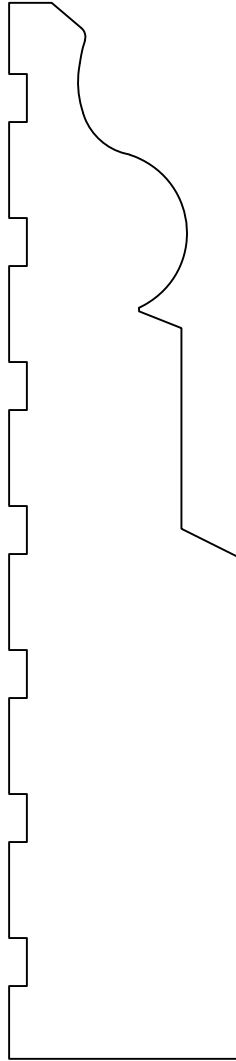

BASE023  
1 3/16" X 5 1/2"

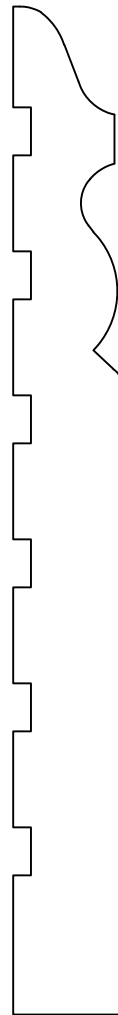

BASE024  
9/16" X 5 1/4"

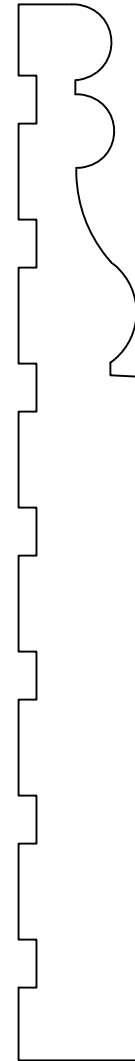

BASE025  
5/8" X 5 1/2"

A08

325 East Drive - Melbourne, FL 32904  
321-308-3297 - Fax 321-308-3299

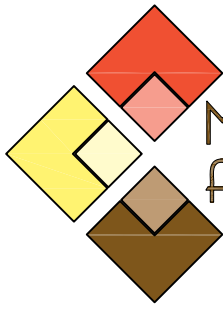

Melbourne  
Architectural  
MILLWORK COMPANY

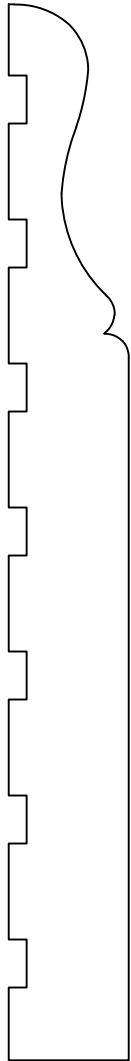

BASE026  
5/8" X 5 1/2"

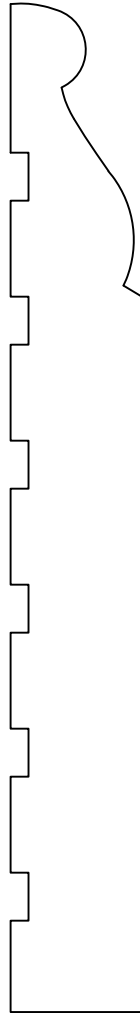

BASE027  
1 1/16" X 5 1/4"

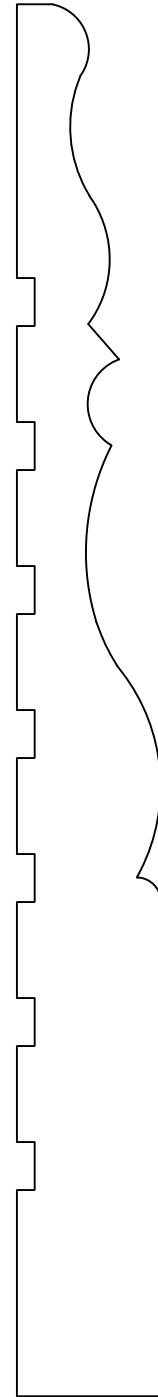

BASE028  
3/4" X 7 1/4"

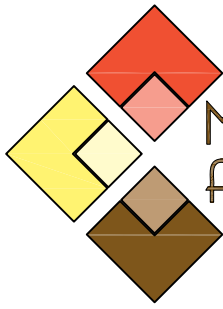

Melbourne  
Architectural  
MILLWORK COMPANY

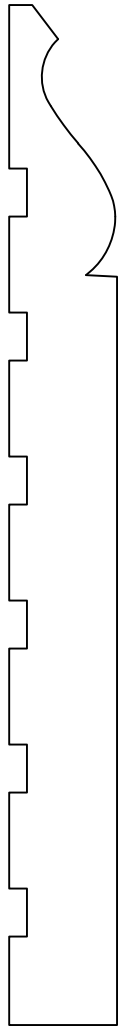

BASE029  
9/16" X 5 5/16"

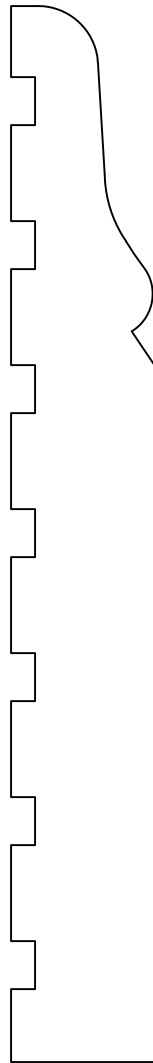

BASE030  
3/4" X 5 1/2"

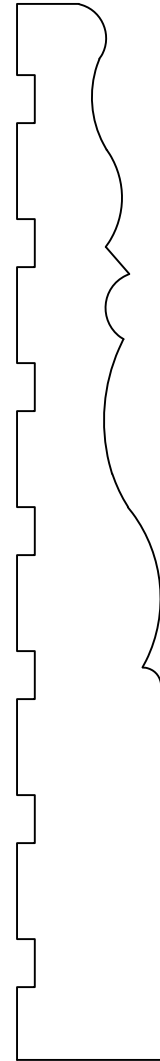

BASE031  
3/4" X 5 1/2"

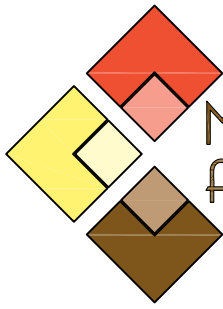

Melbourne  
Architectural  
MILLWORK COMPANY

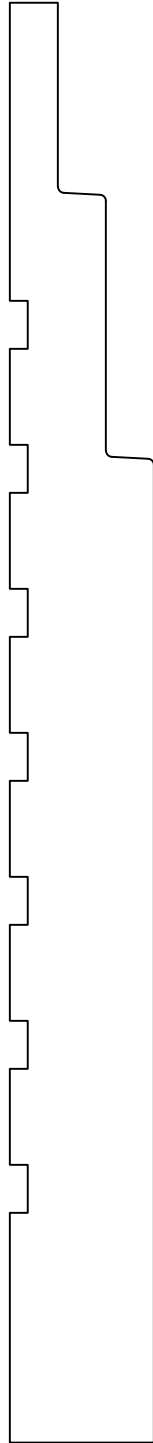

BASE032  
3/4" X 7 1/2"

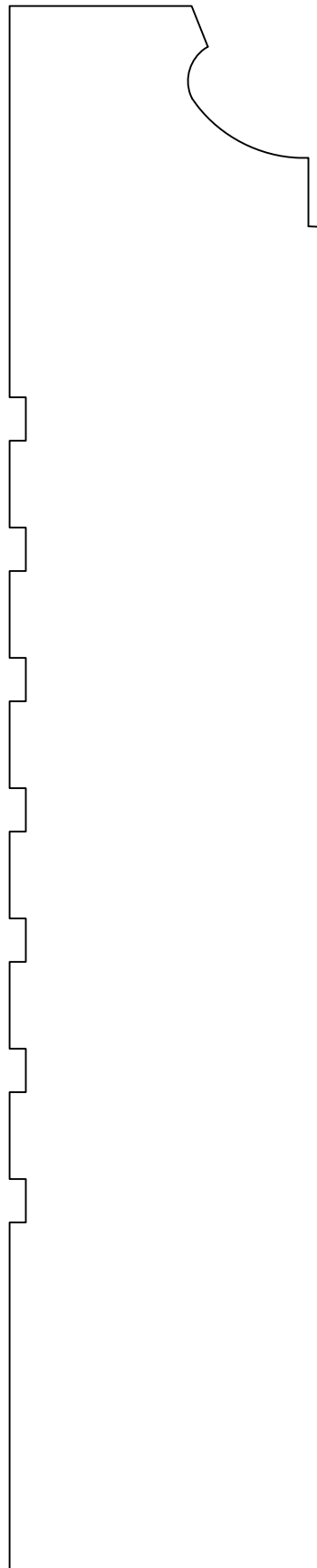

BASE033  
1 13/16" X 9"

325 East Drive - Melbourne, FL 32904  
321-308-3297 - Fax 321-308-3299

A11



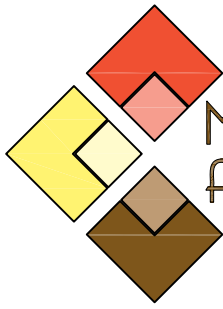

Melbourne  
Architectural  
MILLWORK COMPANY

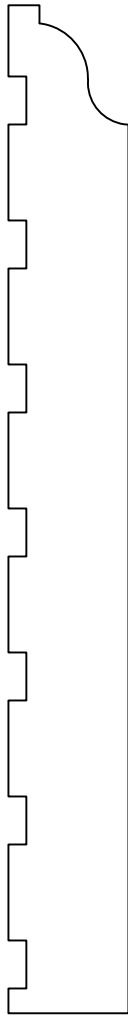

BASE036  
5/8" X 5 1/4"

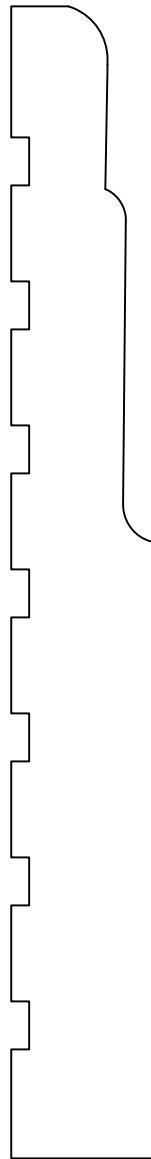

BASE035  
3/4" X 6"

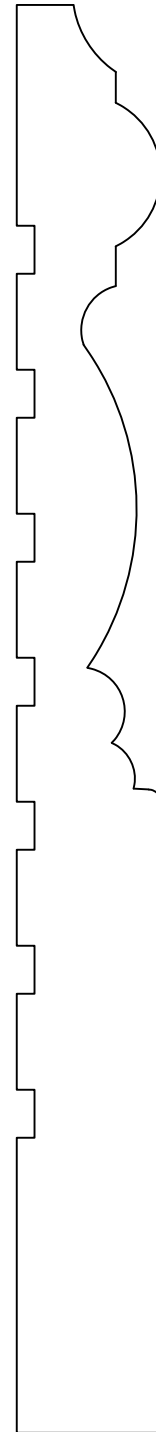

BASE034  
3/4" X 7 7/16"

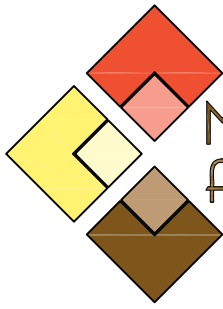

Melbourne  
Architectural  
MILLWORK COMPANY

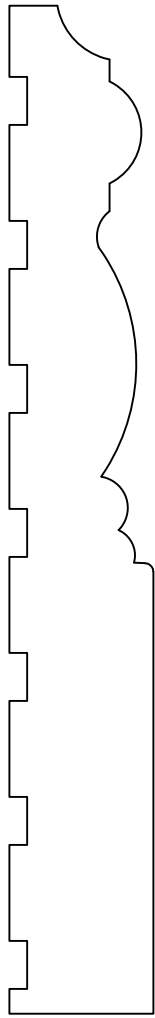

BASE037  
3/4" X 5 1/4"

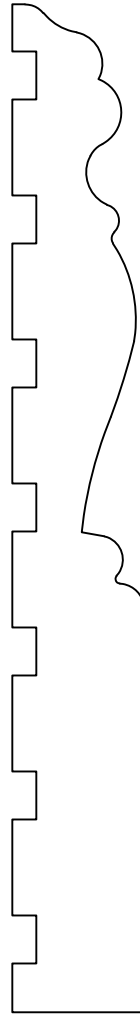

BASE038  
11/16" X 5 1/4"

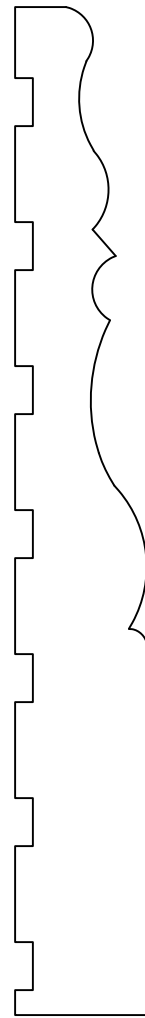

BASE039  
11/16" X 5 1/4"

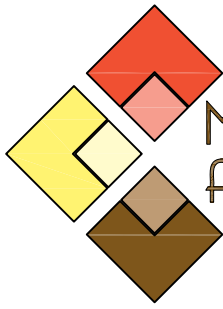

Melbourne  
Architectural  
MILLWORK COMPANY

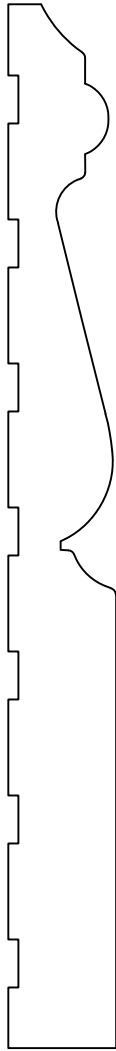

BASE040  
9/16" X 5 7/16"

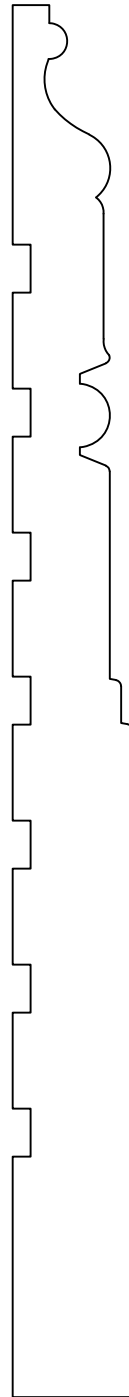

BASE041  
5/8" X 7 1/4"

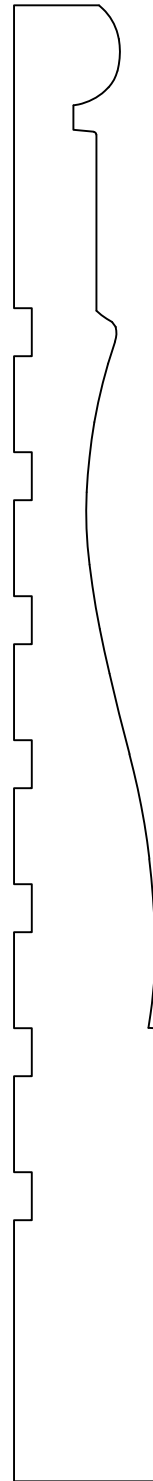

BASE042  
3/4" X 7 11/16"

A14

325 East Drive - Melbourne, FL 32904  
321-308-3297 - Fax 321-308-3299

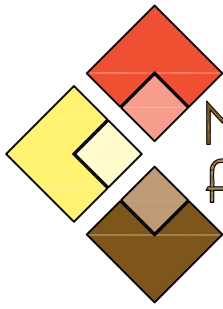

Melbourne  
Architectural  
MILLWORK COMPANY

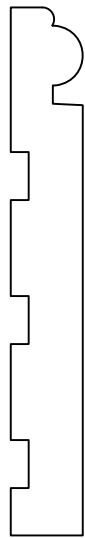

BASE043  
3/8" X 2 3/4"

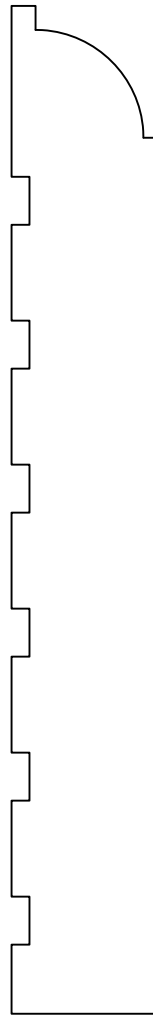

BASE044  
3/4" X 5 1/4"

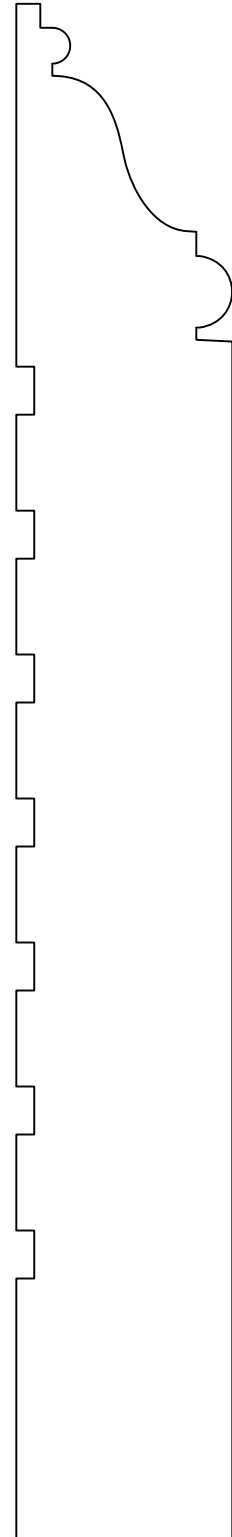

BASE045  
1 1/8" X 8"

325 East Drive - Melbourne, FL 32904  
321-308-3297 - Fax 321-308-3299

A15

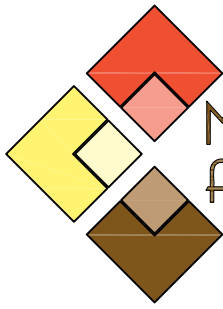

Melbourne  
Architectural  
MILLWORK COMPANY

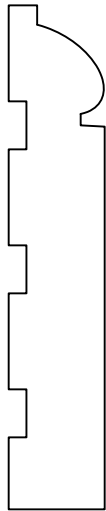

BASE047  
1/2" X 2 5/8"

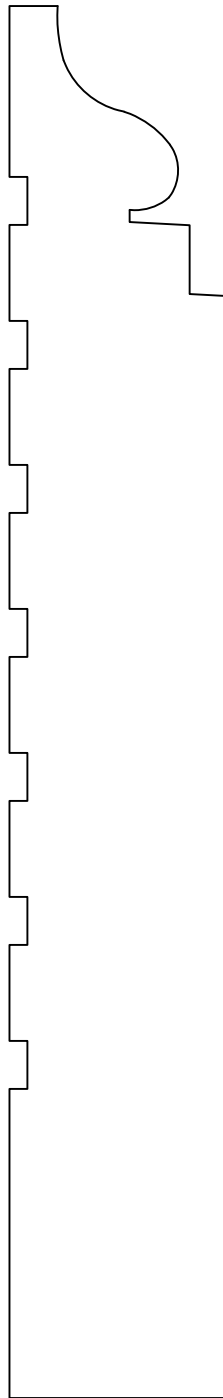

BASE046  
1 1/8" X 7 1/4"

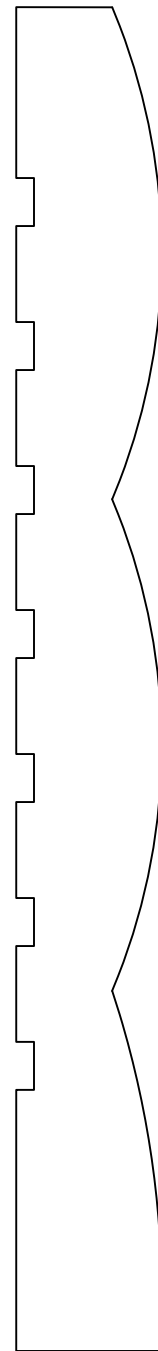

BASE048  
3/4" X 7"

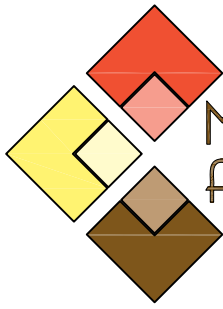

Melbourne  
Architectural  
MILLWORK COMPANY

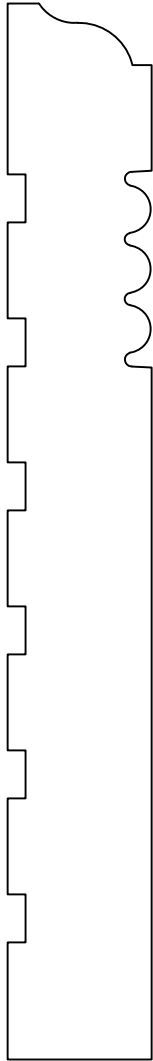

BASE049  
3/4" x 5 1/2"

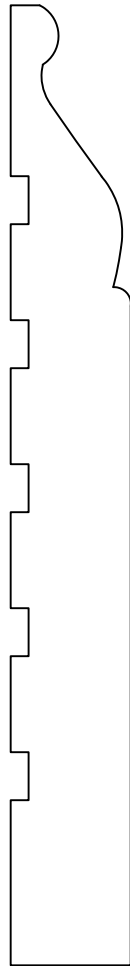

BASE050  
5/8" x 5"

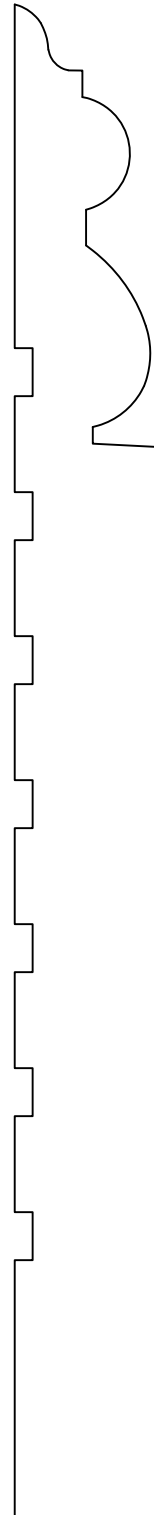

BASE051  
3/4" x 7 7/8"

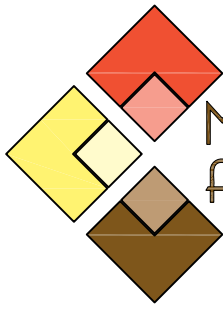

Melbourne  
Architectural  
MILLWORK COMPANY

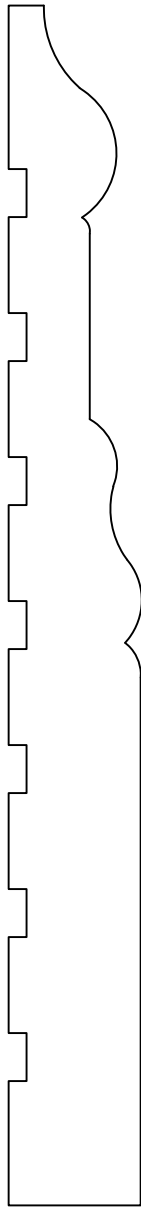

BASE052  
11/16" X 6 1/4"

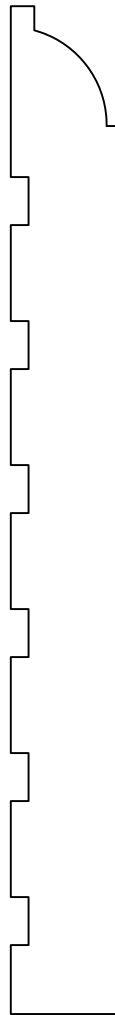

BASE053  
9/16" x 5 1/4"

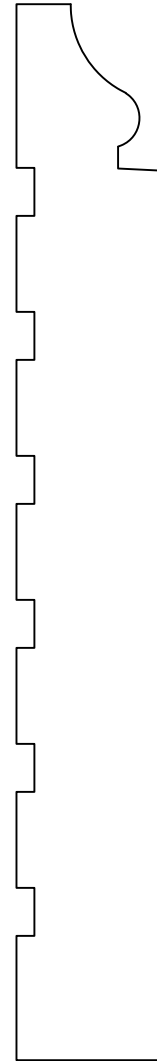

BASE054  
3/4" x 5 1/2"

A18

325 East Drive - Melbourne, FL 32904  
321-308-3297 - Fax 321-308-3299

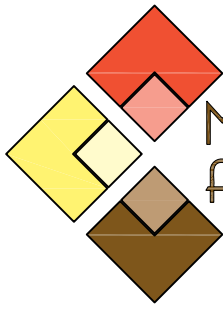

Melbourne  
Architectural  
MILLWORK COMPANY

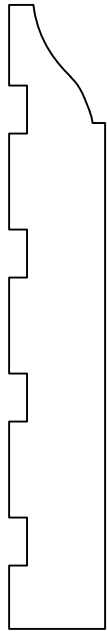

BASE058  
1/2" x 3 1/4"

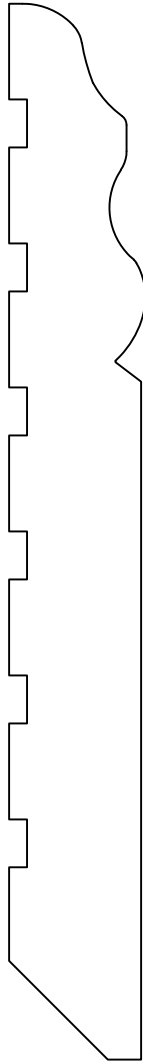

BASE055  
11/16" x 5 1/2"

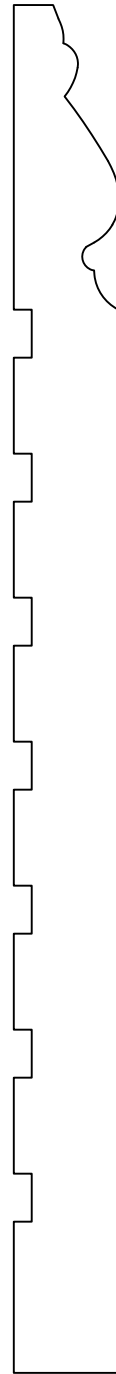

BASE059  
9/16" x 7 1/8"



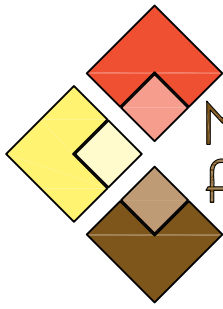

Melbourne  
Architectural  
MILLWORK COMPANY

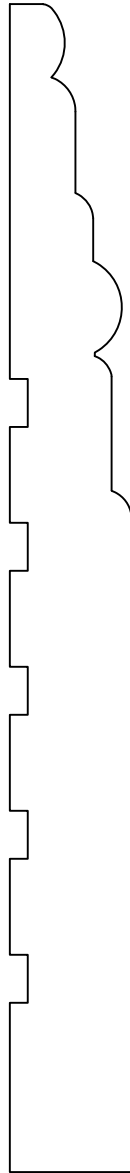

BASE061  
5/8" x 6"

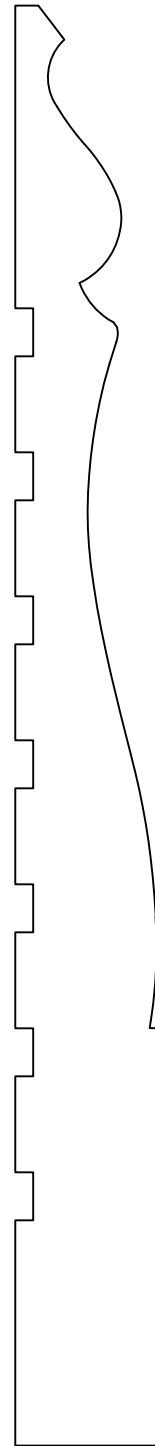

BASE060  
3/4" x 7 1/2"

A20

325 East Drive - Melbourne, FL 32904  
321-308-3297 - Fax 321-308-3299

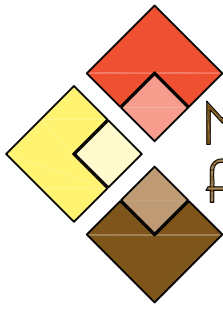

Melbourne  
Architectural  
MILLWORK COMPANY

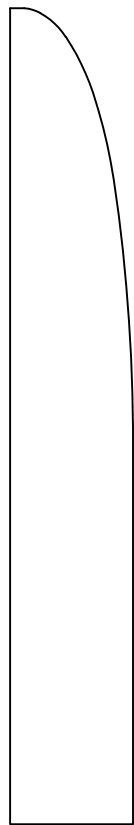

BASE063  
5/8 x 4 1/4

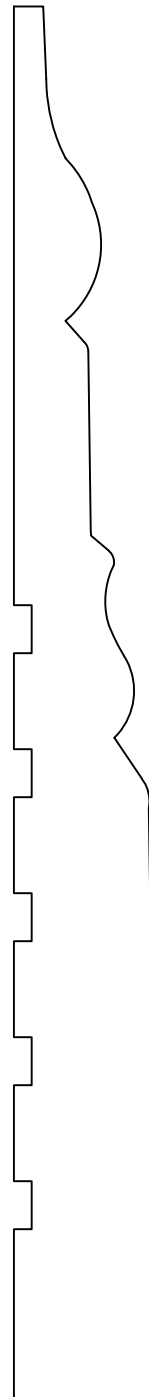

BASE062  
3/4" x 7 1/4"

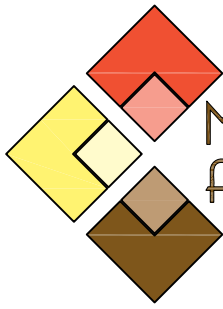

Melbourne  
Architectural  
MILLWORK COMPANY

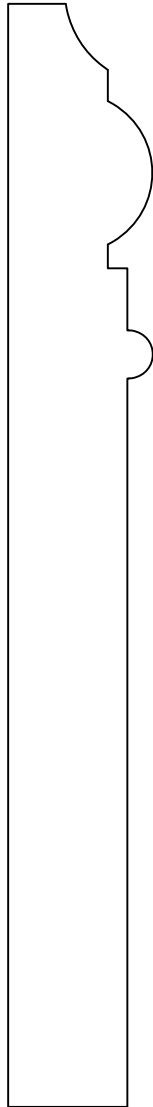

BASE064  
5/8" X 5 3/4"



BASE066  
3/4" X 6 7/16"

A22

325 East Drive - Melbourne, FL 32904  
321-308-3297 - Fax 321-308-3299

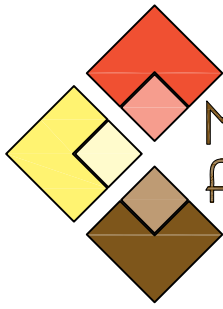

Melbourne  
Architectural  
MILLWORK COMPANY

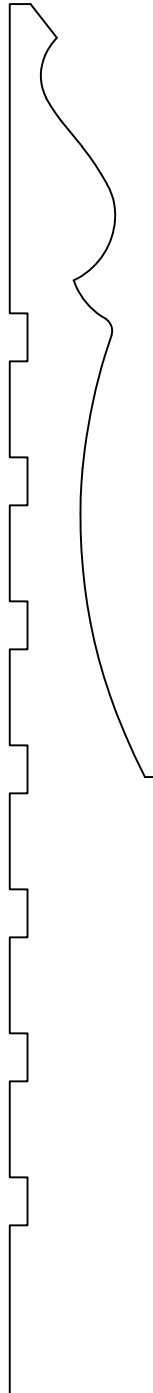

BASE067  
3/4" X 7 1/4"

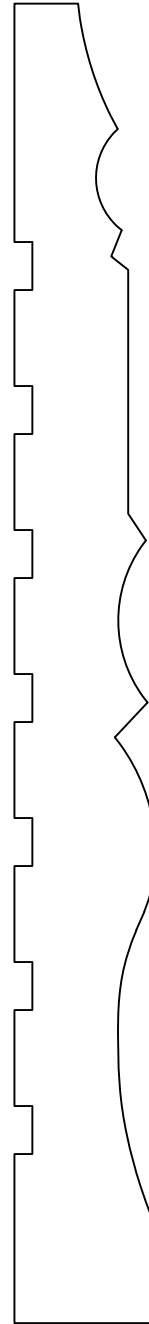

BASE068  
1 1/16" X 6 7/8"

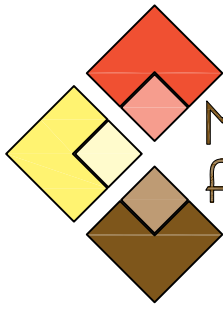

Melbourne  
Architectural  
MILLWORK COMPANY

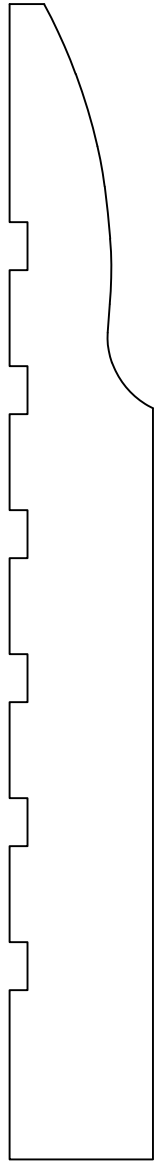

BASE069  
3/4" X 6"

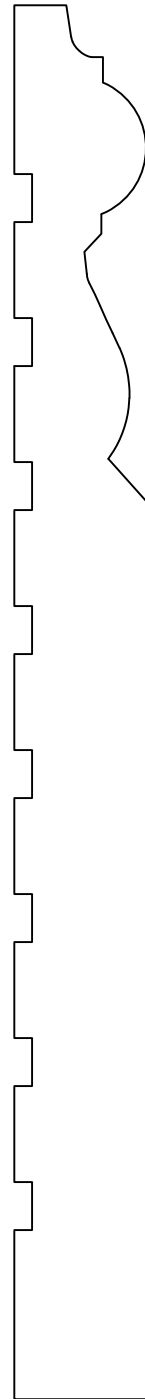

BASE070  
3/4" X 7 1/4"

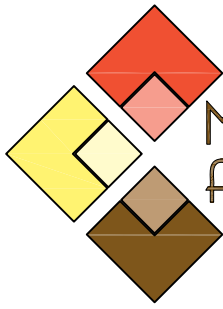

Melbourne  
Architectural  
MILLWORK COMPANY

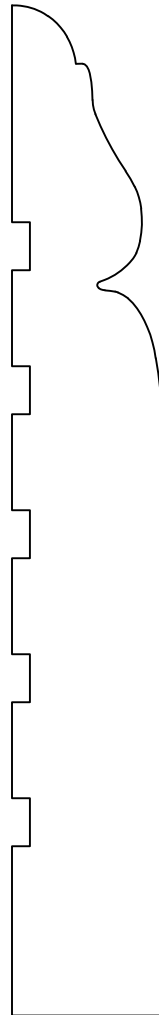

RESERVED FOR  
BASE072

BASE071  
3/4" X 5 1/4 "

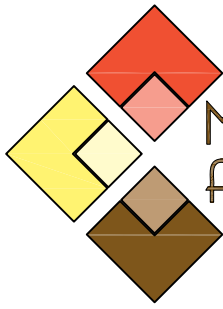

Melbourne  
Architectural  
MILLWORK COMPANY

RESERVED FOR  
BASE073

RESERVED FOR  
BASE074

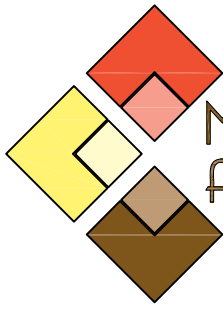

Melbourne  
Architectural  
MILLWORK COMPANY

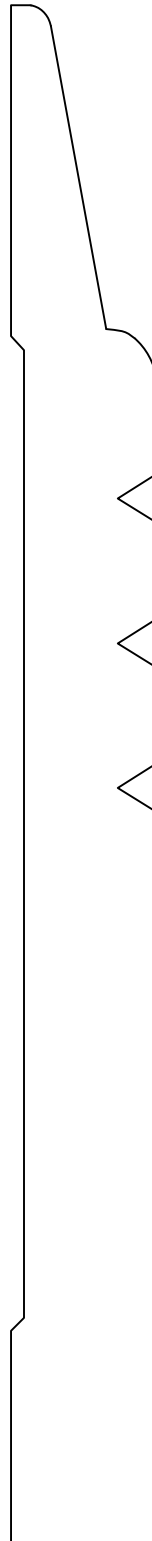

BASE075  
3/4" X 8 "

325 East Drive - Melbourne, FL 32904  
321-308-3297 - Fax 321-308-3299

A27



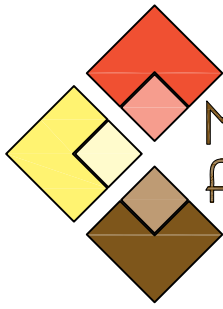

Melbourne  
Architectural  
MILLWORK COMPANY

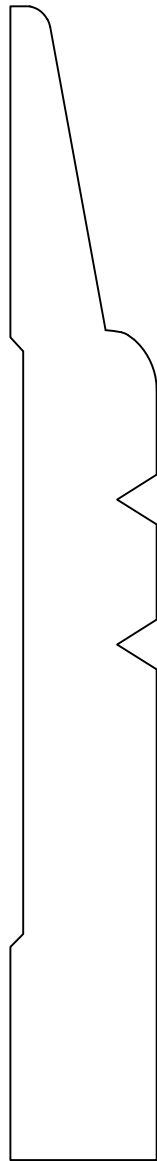

BASE076  
3/4" X 6"

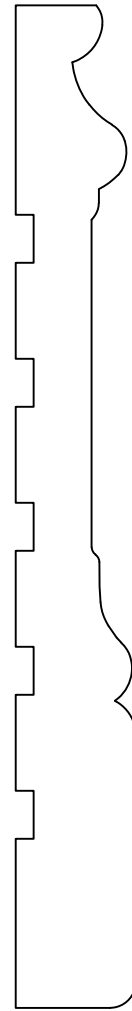

BASE077  
5/8" X 5 1/4"

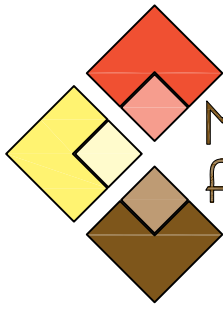

Melbourne  
Architectural  
MILLWORK COMPANY

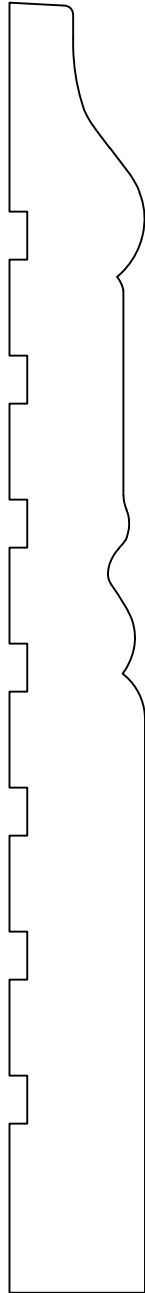

BASE078

1 1/16" X 6 3/4"

325 East Drive - Melbourne, FL 32904  
321-308-3297 - Fax 321-308-3299

A29

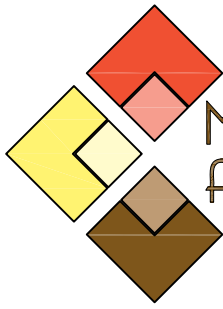

Melbourne  
Architectural  
MILLWORK COMPANY

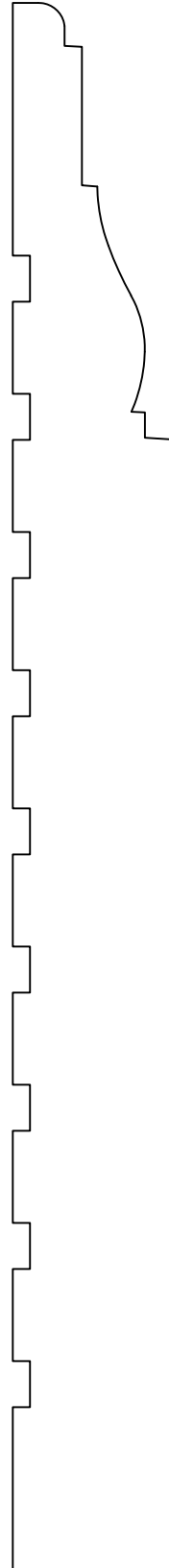

BASE079  
7/8" X 8 1/2"

A30

325 East Drive - Melbourne, FL 32904  
321-308-3297 - Fax 321-308-3299

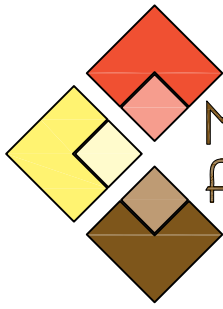

Melbourne  
Architectural  
MILLWORK COMPANY

BASE080  
11/16" X 7 1/4 "

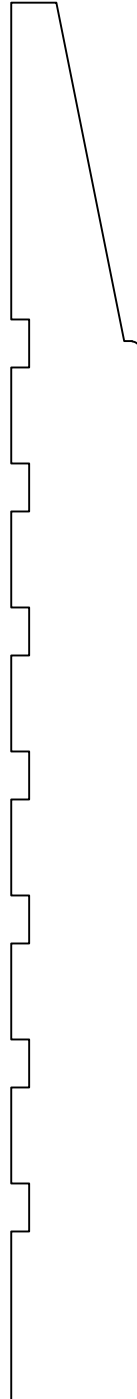

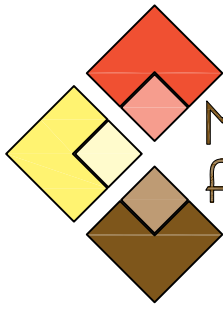

Melbourne  
Architectural  
MILLWORK COMPANY

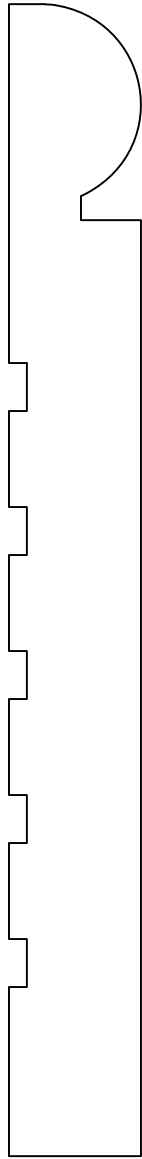

BASE081  
11/16" X 6 "

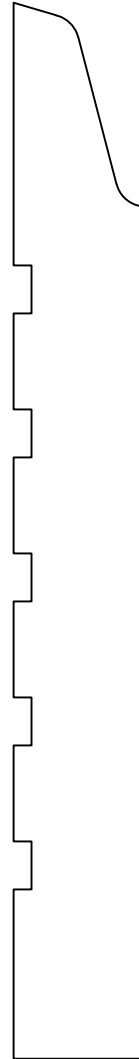

BASE082  
11/16" X 5 1/2 "

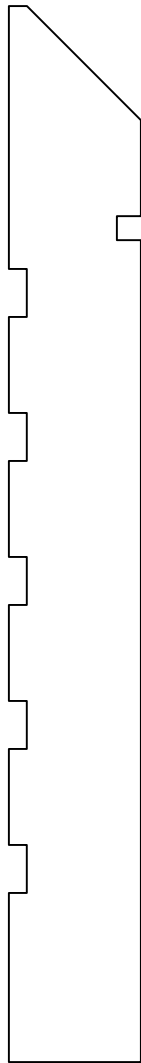

BASE083  
11/16" X 5 1/2 "

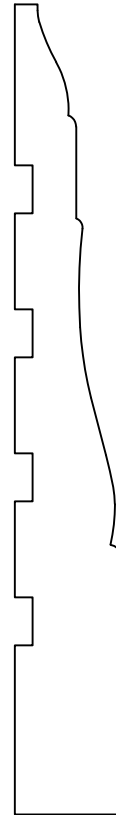

BASE084  
9/16" x 6"

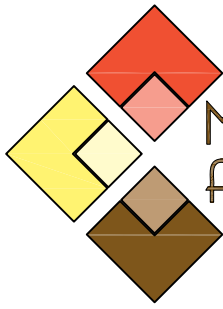

Melbourne  
Architectural  
MILLWORK COMPANY

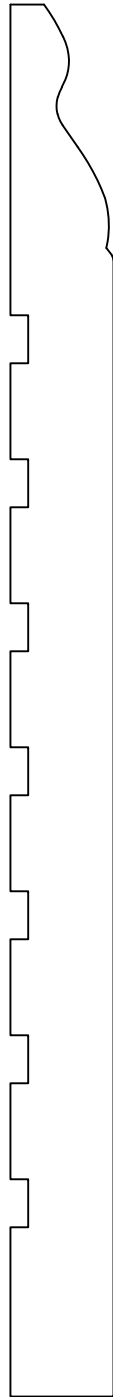

BASE085  
9/16" x 7 1/4"

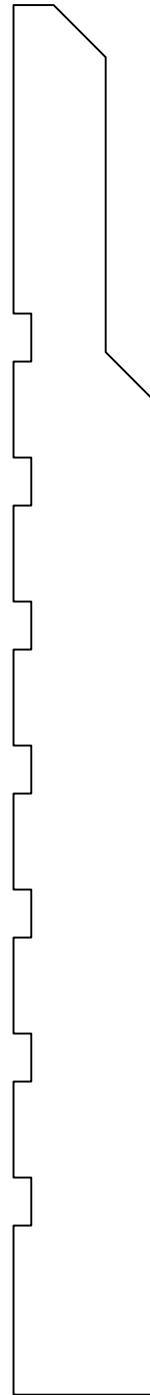

BASE086  
3/4" x 7 1/4"

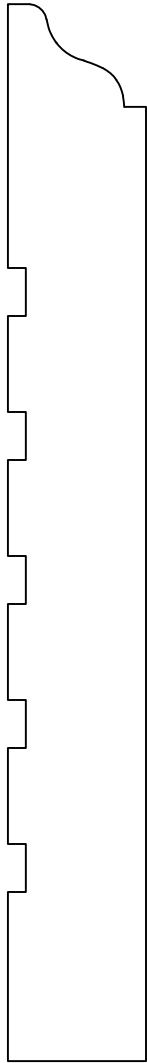

BASE087  
11/16" x 5 1/2"

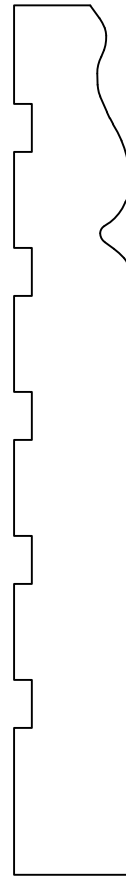

BASE088  
5/8" x 4 1/2"



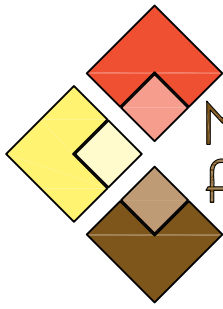

Melbourne  
Architectural  
MILLWORK COMPANY

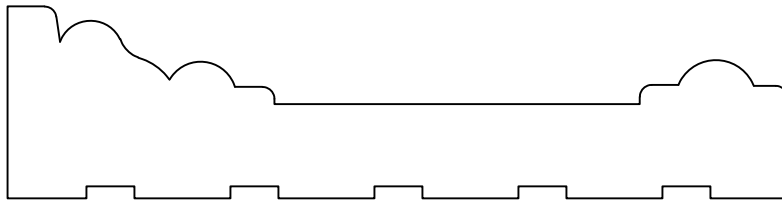

CASG001  
1" x 4 1/16"

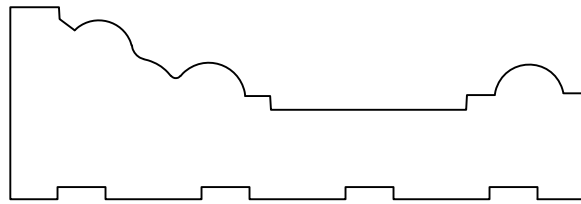

CASG002  
1" x 3"

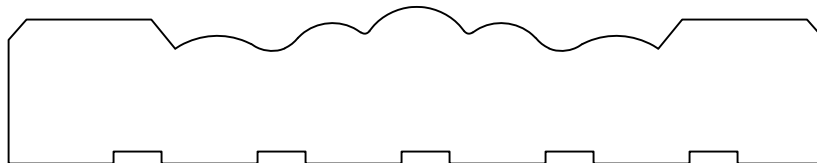

CASG003  
3/4" x 4 1/4"

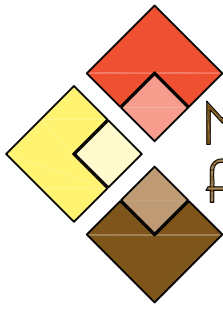

Melbourne  
Architectural  
MILLWORK COMPANY

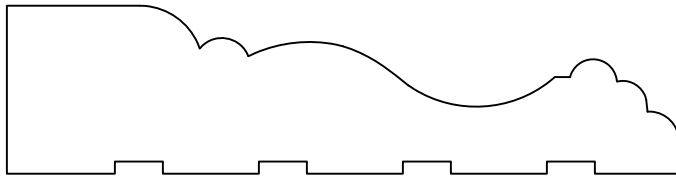

CASG004  
7/8" x 3 1/2"

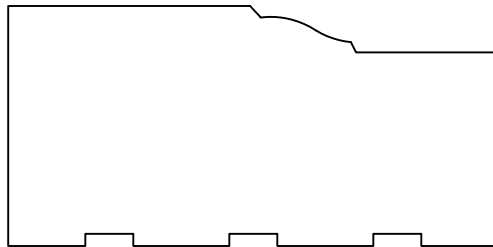

CASG005  
1 1/4" x 2 9/16"

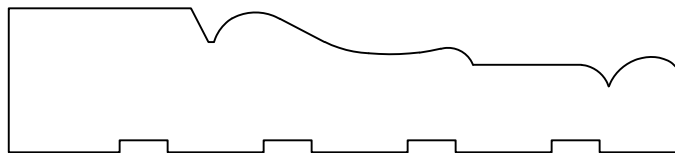

CASG006  
3/4" x 3 1/2"

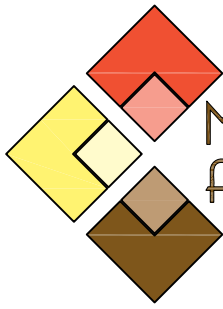

Melbourne  
Architectural  
MILLWORK COMPANY

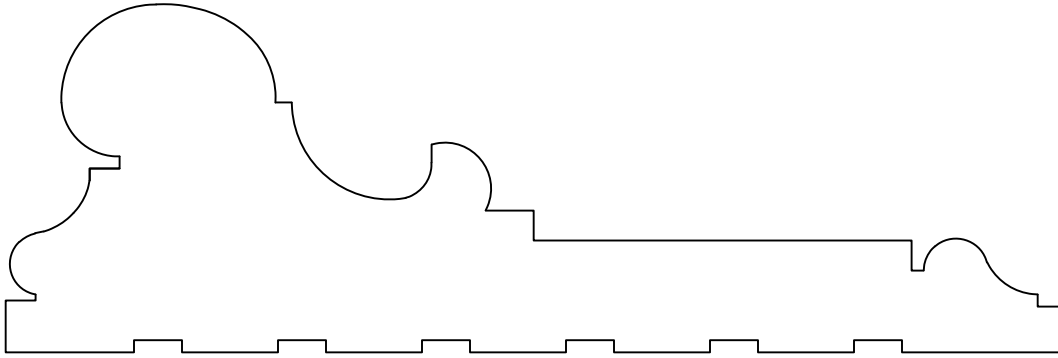

CASG007

1 13/16" X 5 1/2"

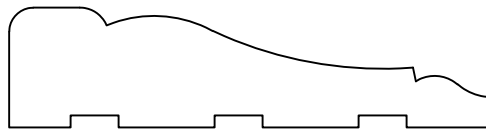

CASG008

5/8" X 2 1/2"

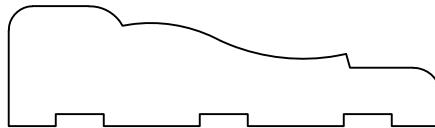

CASG009

5/8" X 2 1/4"

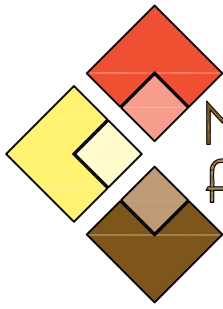

Melbourne  
Architectural  
MILLWORK COMPANY

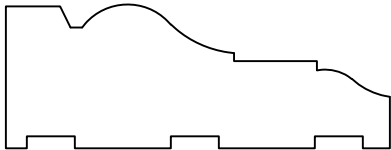

CASG010  
3/4" X 2"

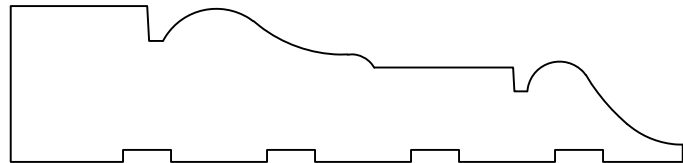

CASG011  
13/16" x 3 1/2"

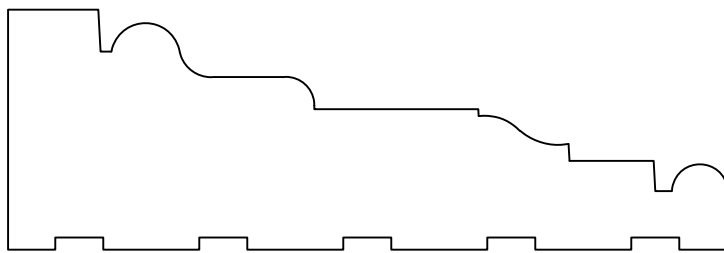

CASG012  
1 1/4" X 3 3/4"

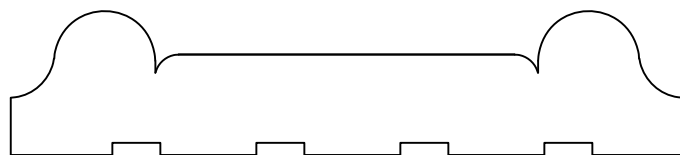

CASG013  
3/4" X 3 1/2"

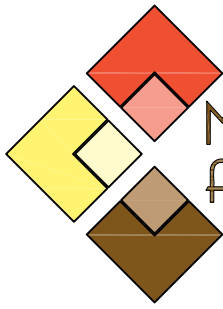

Melbourne  
Architectural  
MILLWORK COMPANY

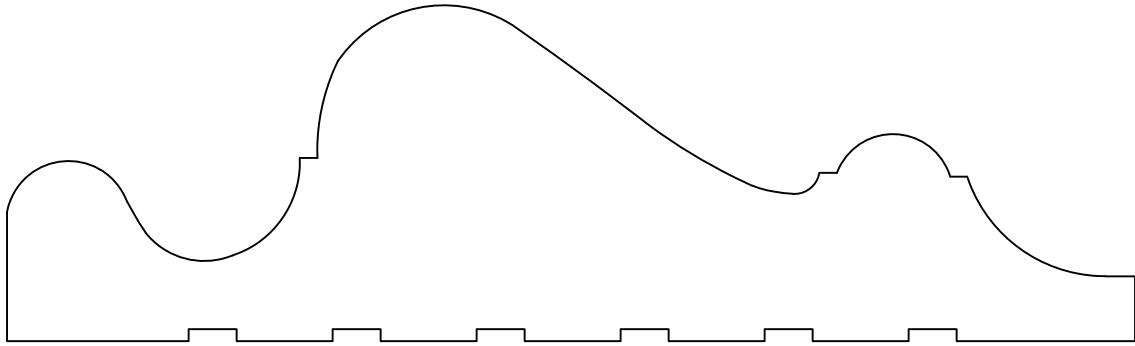

CASG014  
1 3/4" X 5 7/8"

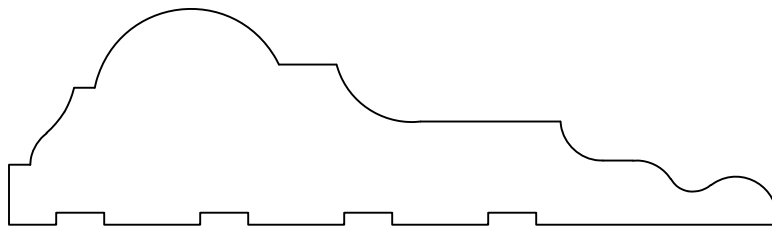

CASG015  
1 1/8" X 4"

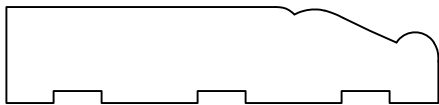

CASG016  
1/2" X 2 1/4"

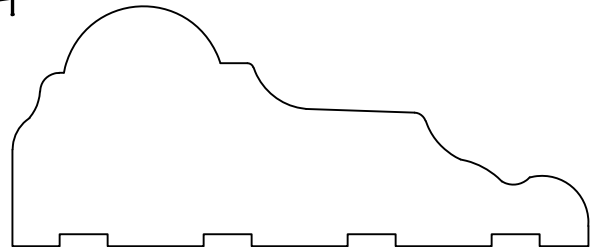

CASG017  
1 1/4" X 3"

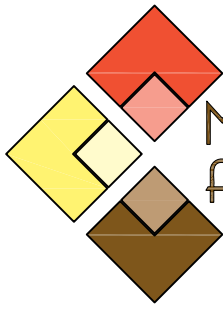

Melbourne  
Architectural  
MILLWORK COMPANY

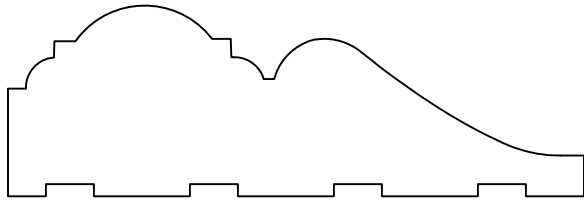

CASG018  
1" X 3"

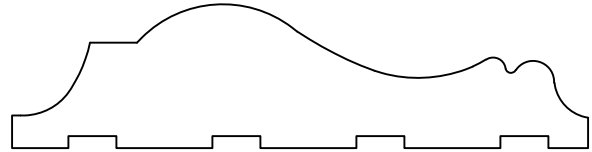

CASG019  
3/4" X 3"

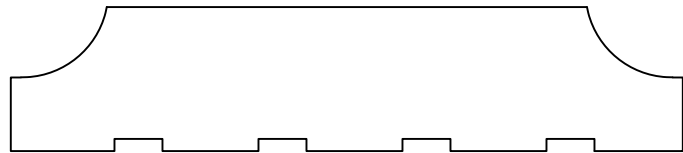

CASG021  
3/4" X 3 1/2"

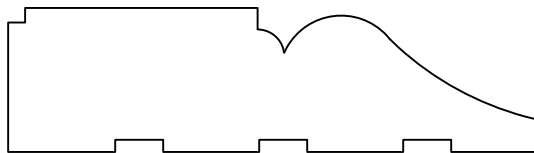

CASG020  
3/4" X 2 3/4"

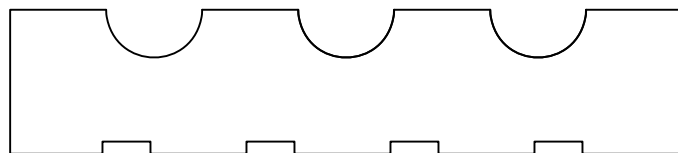

CASG022  
3/4" X 3 1/2"

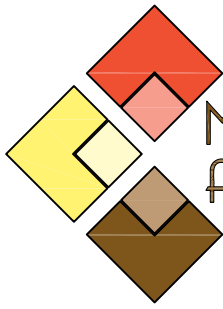

Melbourne  
Architectural  
MILLWORK COMPANY

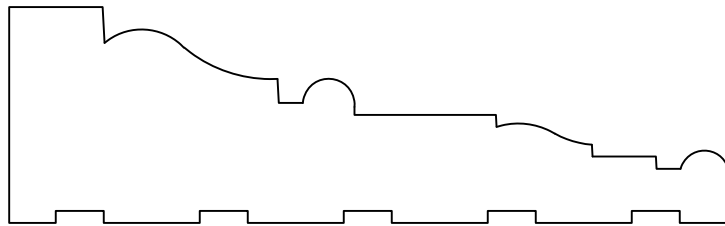

CASG023  
1 1/8" X 3 3/4"

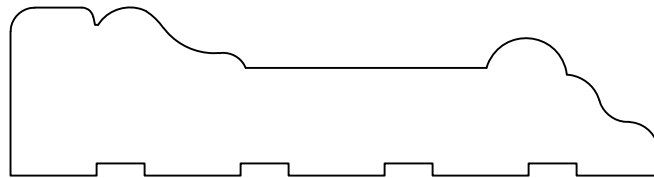

CASG024  
7/8" X 3 3/8"

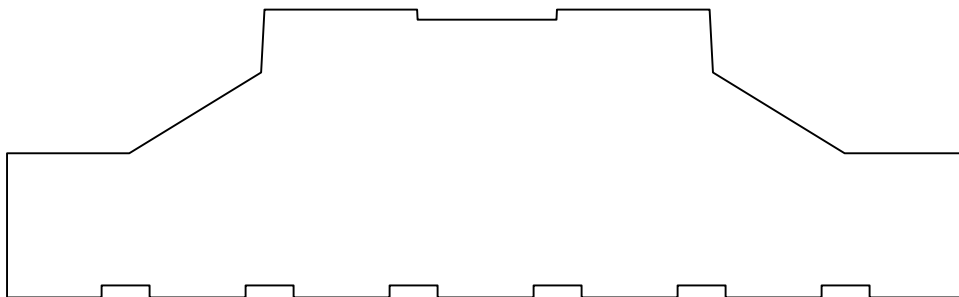

CASG025  
1 1/2" X 5"

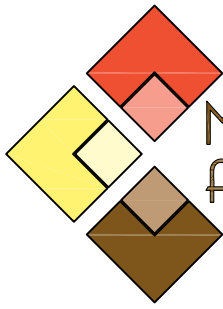

Melbourne  
Architectural  
MILLWORK COMPANY

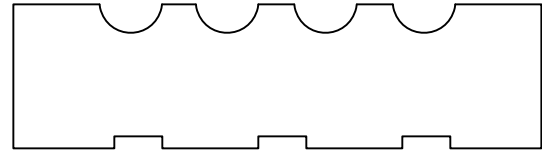

CASG027  
3/4" X 2 3/4"

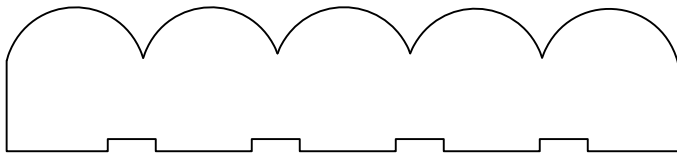

CASG026  
3/4" X 3 1/2"

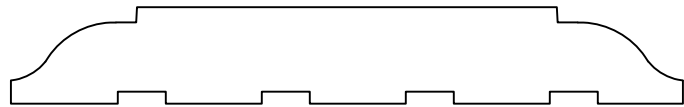

CASG029  
1/2" X 3 1/2"

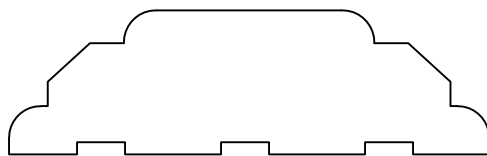

CASG028  
3/4" X 2 1/2"

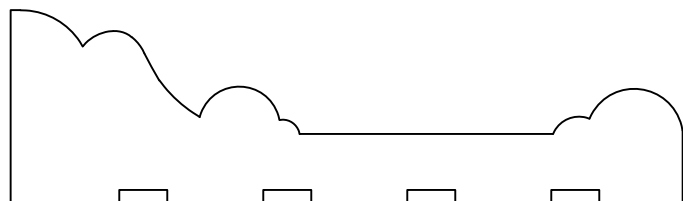

CASG030  
1" X 3 1/2"



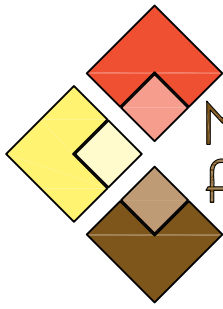

Melbourne  
Architectural  
MILLWORK COMPANY

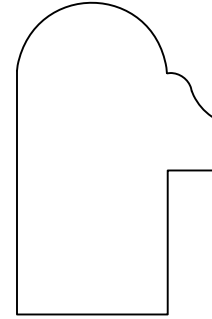

CASG032  
1 5/8" X 1 1/16"

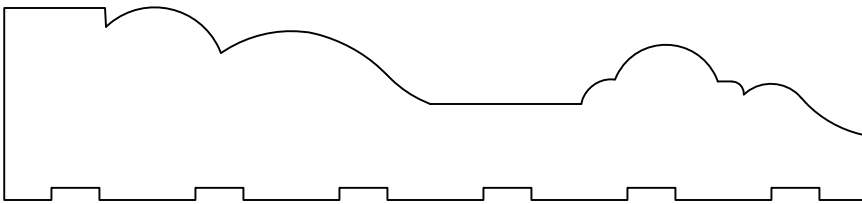

CASG031  
1" X 4 1/2"

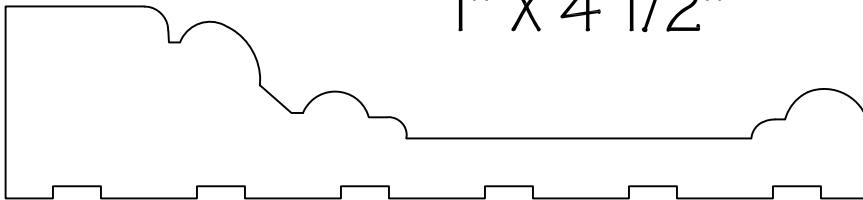

CASG033  
1" X 4 1/2"

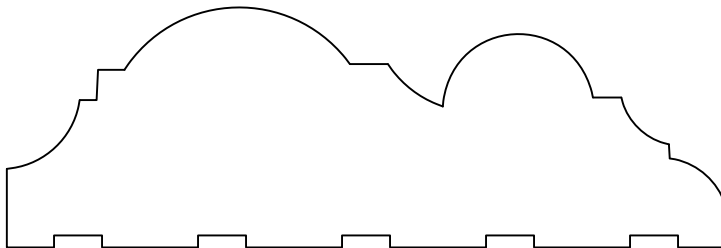

CASG034  
1 1/4" X 3 3/4"

325 East Drive - Melbourne, FL 32904  
321-308-3297 - Fax 321-308-3299

B09

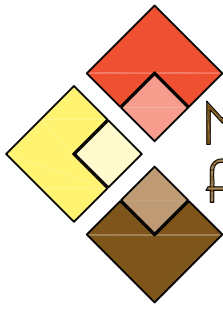

Melbourne  
Architectural  
MILLWORK COMPANY

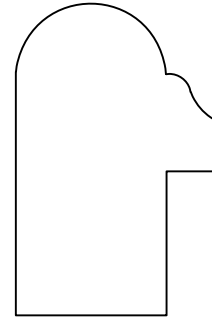

CASG032

1 5/8" X 1 1/16"

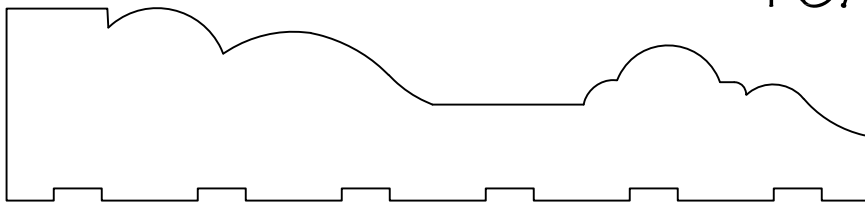

CASG031

1" X 4 1/2"

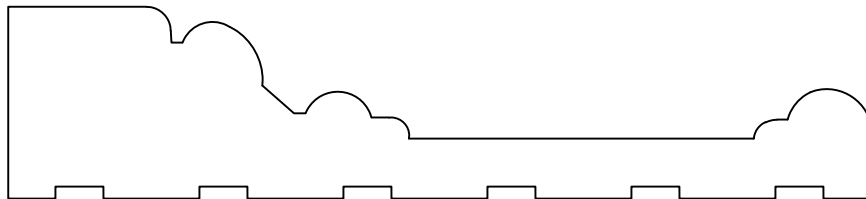

CASG033

1" X 4 1/2"

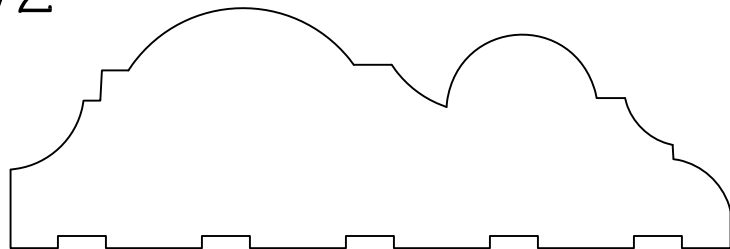

CASG034

1 1/4" X 3 3/4"

B10

325 East Drive - Melbourne, FL 32904  
321-308-3297 - Fax 321-308-3299

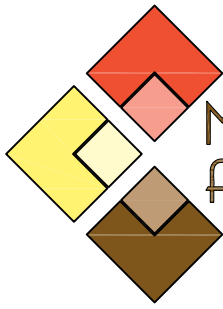

Melbourne  
Architectural  
MILLWORK COMPANY

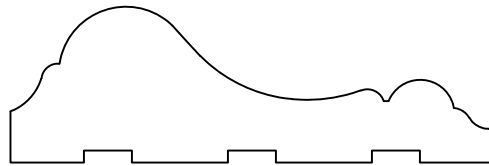

CASG035  
13/16" X 2 1/2"

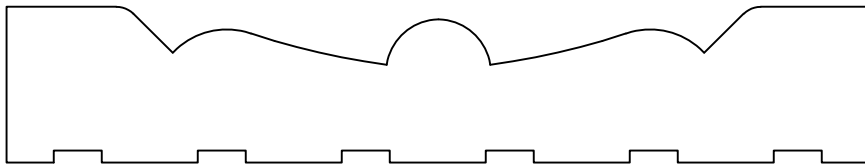

CASG036  
13/16" X 4 1/2"

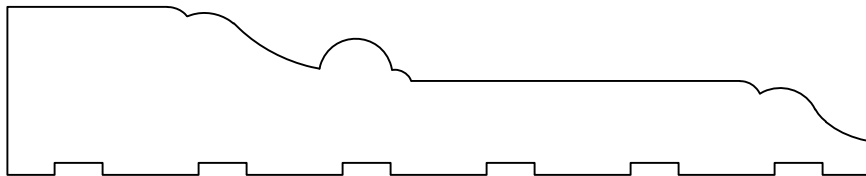

CASG037  
7/8" X 4 1/2"

325 East Drive - Melbourne, FL 32904  
321-308-3297 - Fax 321-308-3299

B11

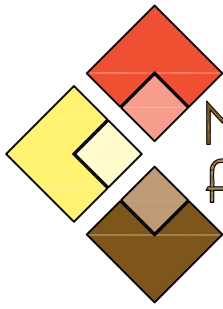

Melbourne  
Architectural  
MILLWORK COMPANY

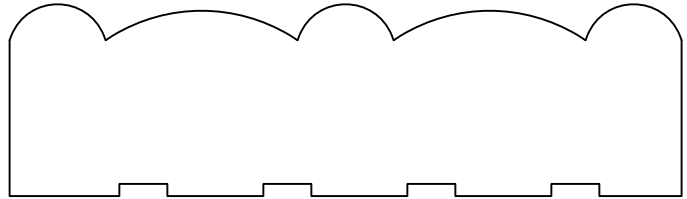

CASG039  
1" X 3 1/2"

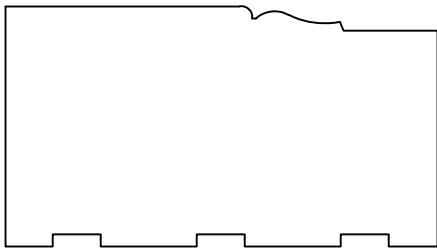

CASG038  
1 1/4" X 2 1/4"

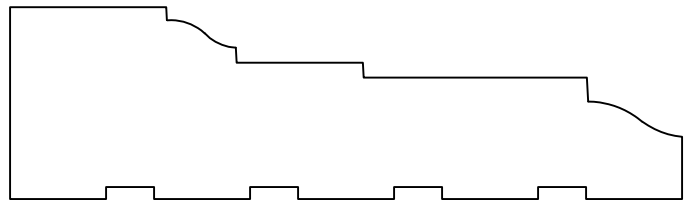

CASG041  
1" X 3 1/2"

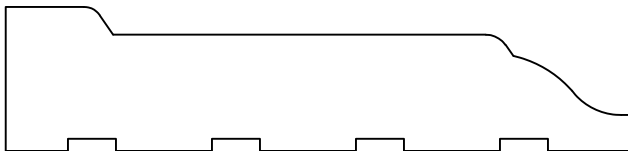

CASG040  
3/4" X 3 1/4"

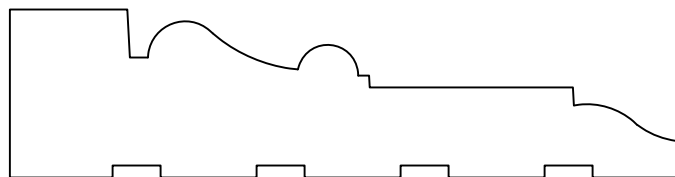

CASG042  
7/8" X 3 1/2"

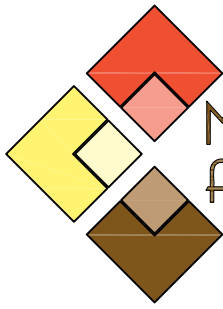

Melbourne  
Architectural  
MILLWORK COMPANY

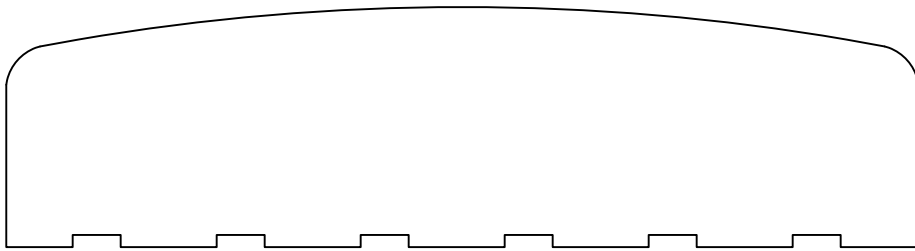

CASG043

1 1/4" X 4 3/4"

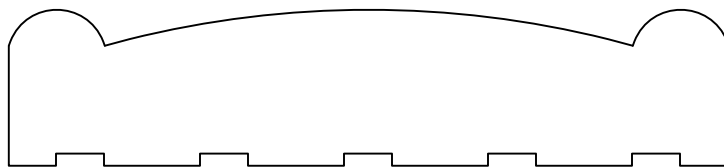

CASG044

13/16" X 3 3/4"

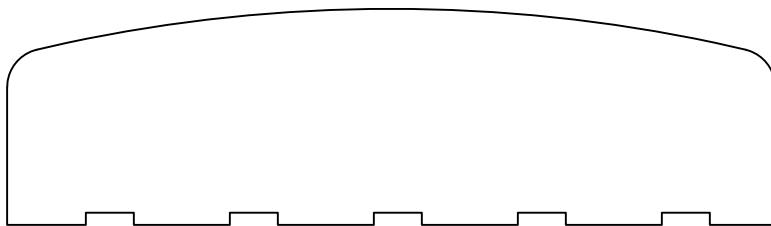

CASG045

1 1/8" X 4"

325 East Drive - Melbourne, FL 32904  
321-308-3297 - Fax 321-308-3299

B13

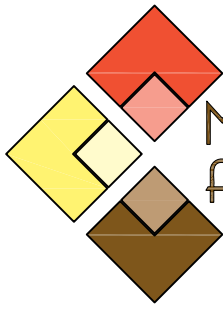

Melbourne  
Architectural  
MILLWORK COMPANY

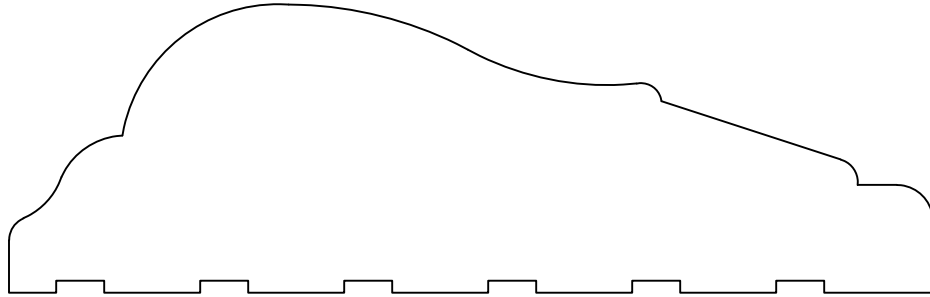

CASG046  
1 1/2" X 4 13/16"

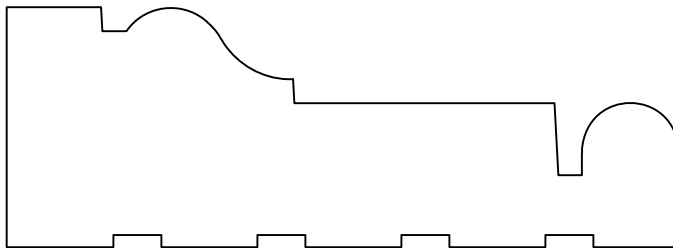

CASG047  
1 1/4" X 3 1/2"

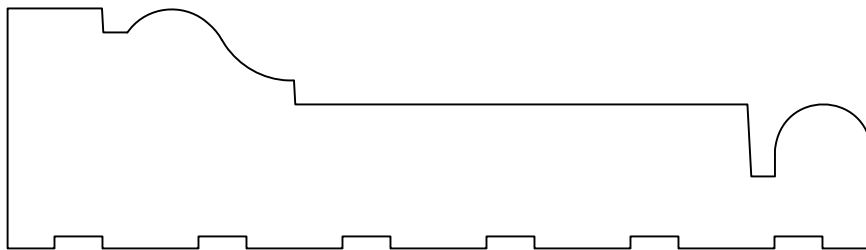

CASG048  
1 1/4" X 4 1/2"

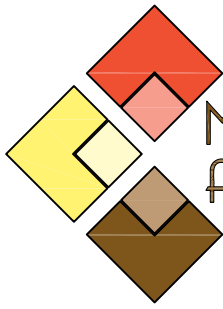

Melbourne  
Architectural  
MILLWORK COMPANY

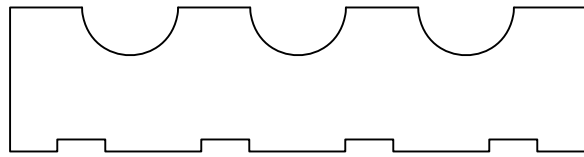

CASG051

3/4" X 3"

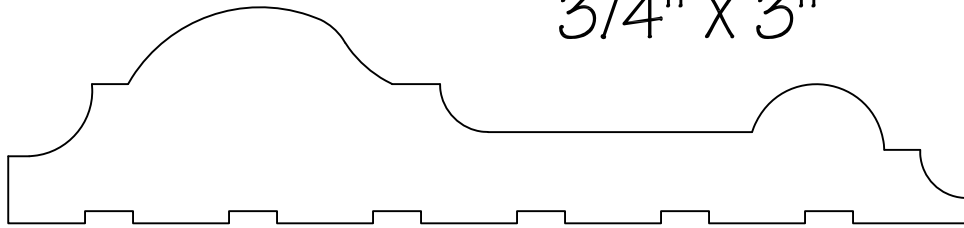

CASG049

1 1/8" X 5"

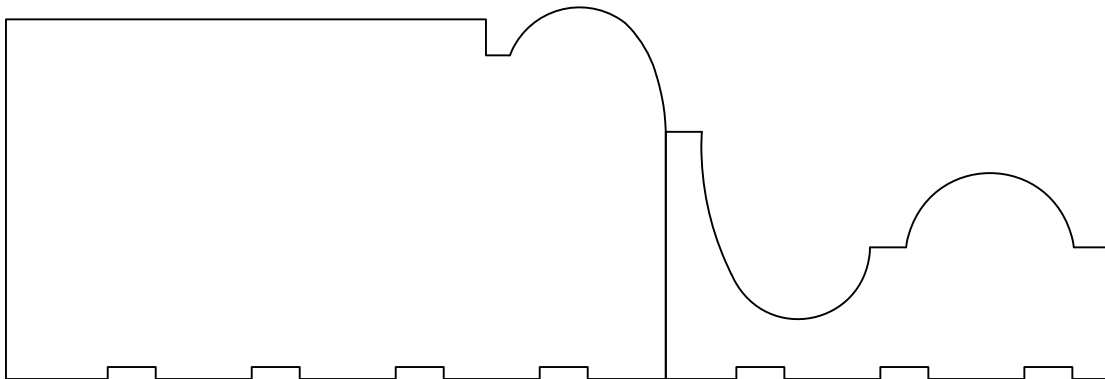

2 PC. BASE CASG050

1 15/16" X 5 3/4"

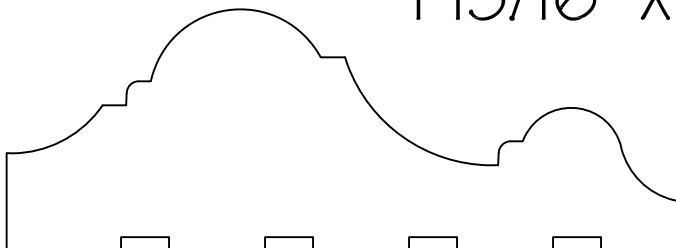

CASG052

1 1/4" X 3 1/2"

325 East Drive - Melbourne, FL 32904  
321-308-3297 - Fax 321-308-3299

B15

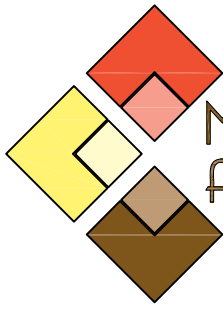

Melbourne  
Architectural  
MILLWORK COMPANY

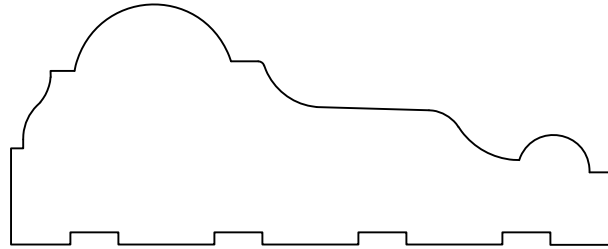

CASG054  
1 1/4" X 3 1/8"

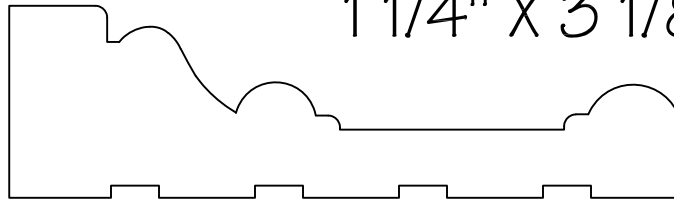

CASG053  
1" X 3 1/2"

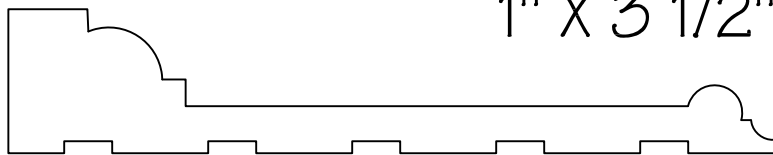

CASG055  
3/4" X 4"

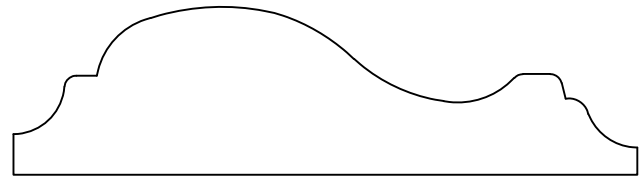

CASG056  
7/8" x 3 1/4"

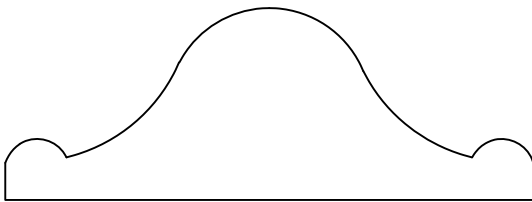

CASG057  
1" X 2 3/4"

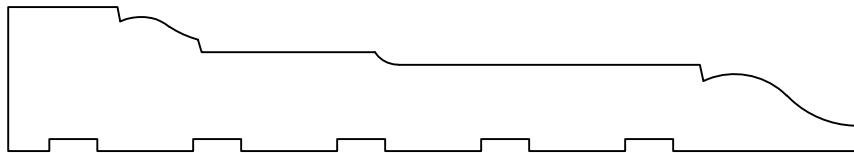

CASG058 3/4" X 4 7/16"



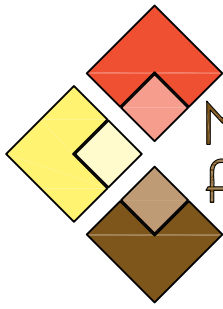

Melbourne  
Architectural  
MILLWORK COMPANY

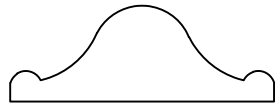

CASG059

1/2" X 1 3/8"

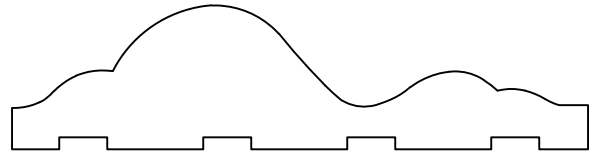

CASG060

3/4" X 3"

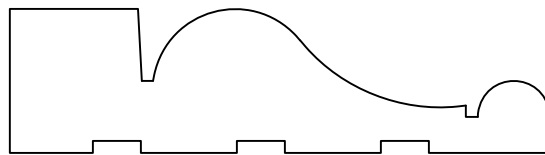

CASG061

3/4" X 2 13/16"

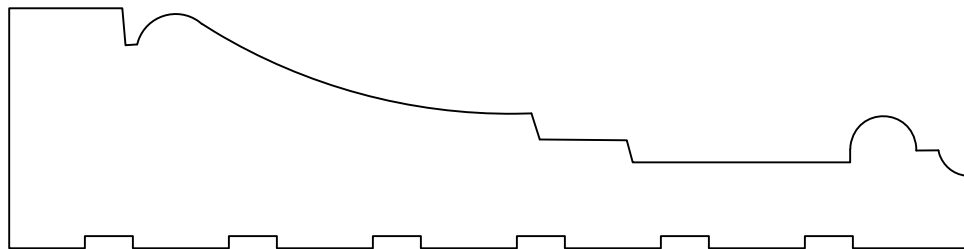

CASG062

1 1/4" X 5"

325 East Drive - Melbourne, FL 32904  
321-308-3297 - Fax 321-308-3299

B17

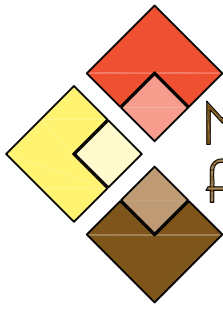

Melbourne  
Architectural  
MILLWORK COMPANY

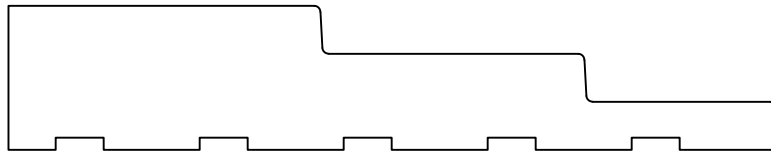

CASG063  
3/4" X 4"

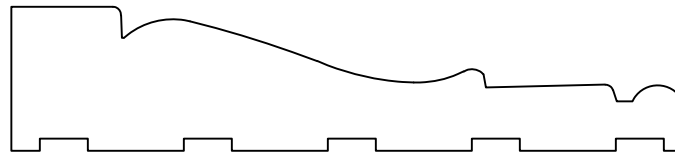

CASG064  
3/4" X 3 1/2"

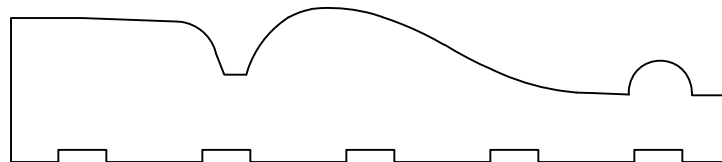

CASG065  
3/4" X 3 3/4"

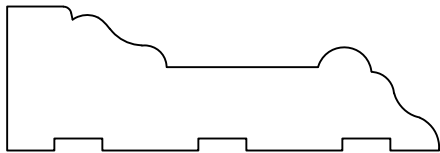

CASG066  
3/4" X 2 1/4"

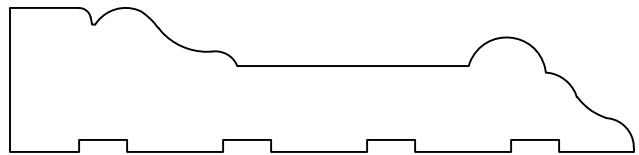

CASG067  
3/4" X 3 1/4"

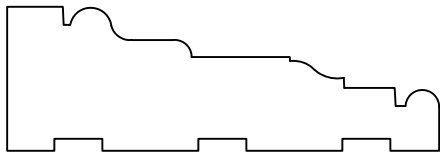

CASG068  
3/4" X 2 1/4"

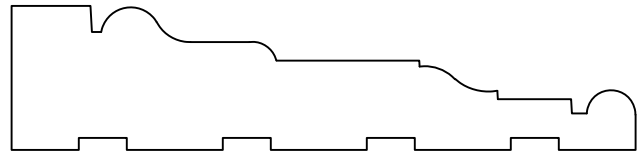

CASG069  
3/4" X 3 1/4"

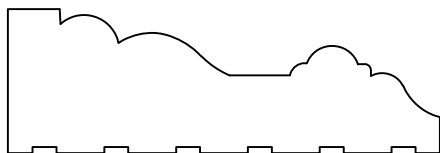

CASG070  
3/4" x 2 1/4"

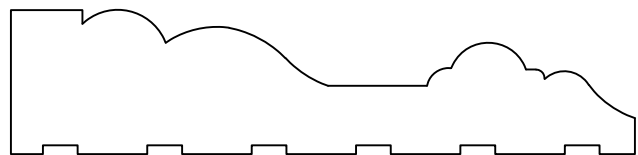

CASG071  
3/4" x 3 1/4"

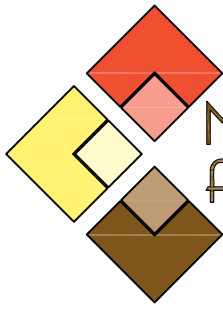

Melbourne  
Architectural  
MILLWORK COMPANY

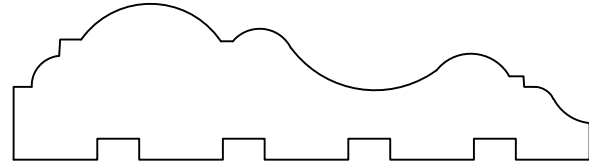

CASG073

13/16" X 3"

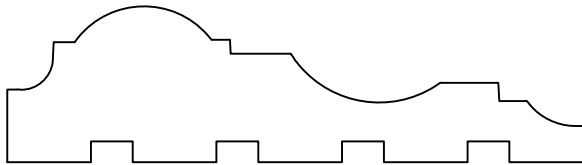

CASG072

13/16" X 3"

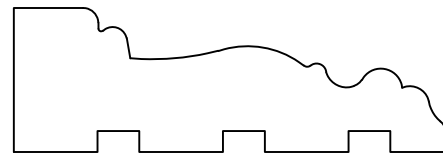

CASG075

3/4" X 2 1/4"

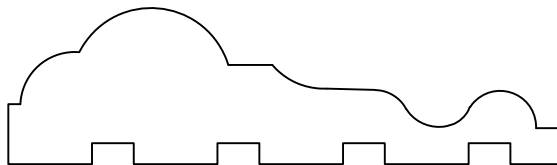

CASG074

13/16" X 2 7/8"

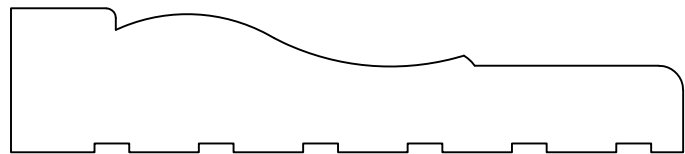

CASG077

3/4" X 3 1/2"

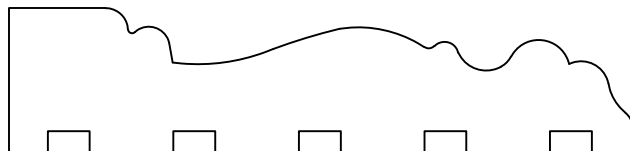

CASG076

3/4" X 3 1/4"

B20

325 East Drive - Melbourne, FL 32904  
321-308-3297 - Fax 321-308-3299

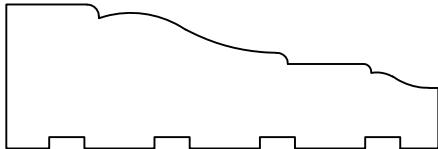

CASG078  
3/4" X 2 1/4"

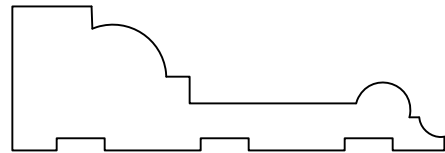

CASG079  
3/4" X 2 1/4"

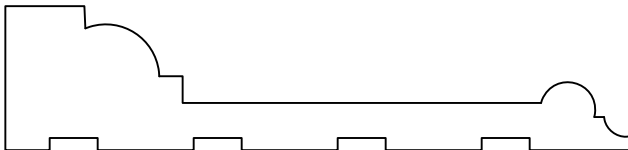

CASG080  
3/4" X 3 1/4"

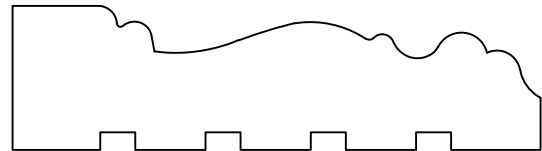

CASG081  
3/4" x 2 3/4"

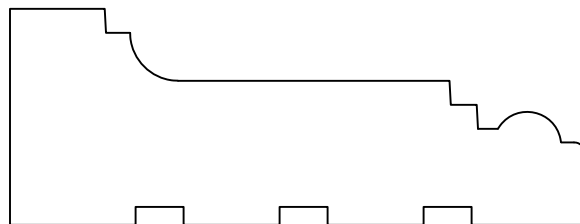

CASG082  
1 1/8" X 3"

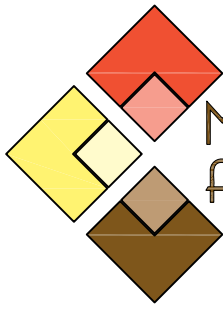

Melbourne  
Architectural  
MILLWORK COMPANY

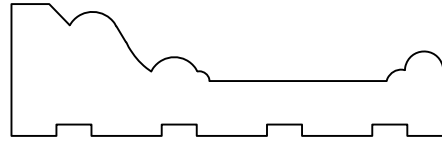

CASG084  
1 1/16" X 2 1/4"

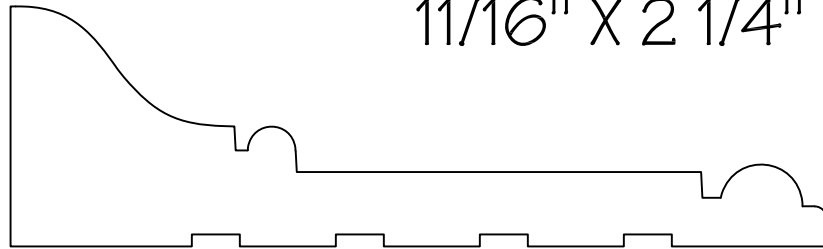

CASG083  
1 1/4" X 4 1/4"

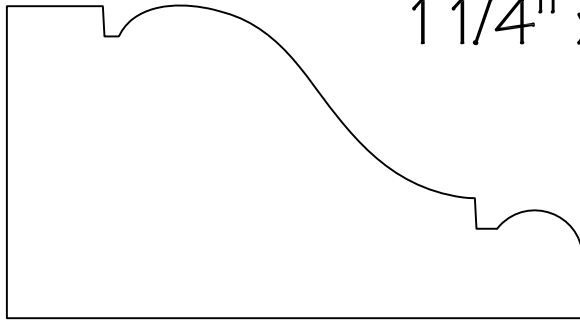

CASG085  
1 5/8" X 3"

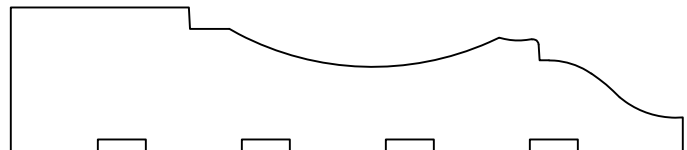

CASG087  
3/4" X 3 1/2"

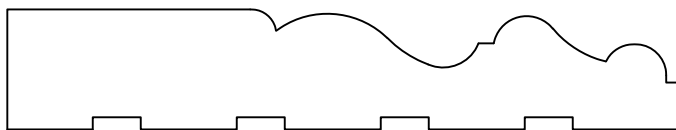

CASG086  
5/8" X 3 1/2"

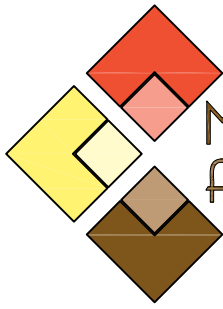

Melbourne  
Architectural  
MILLWORK COMPANY

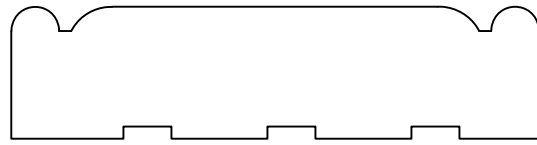

CASG089

1 1/16" X 2 3/4"

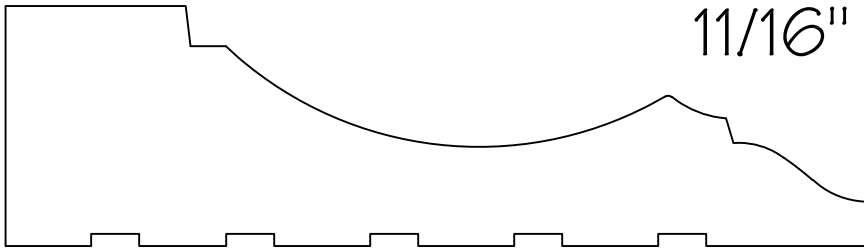

CASG088

1 1/4" X 4 1/2"

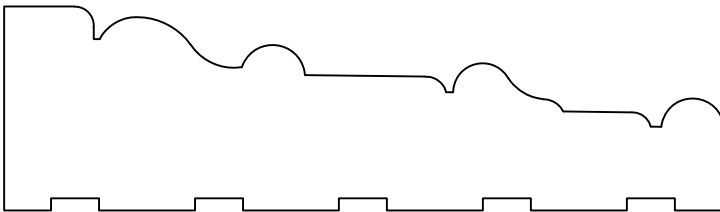

CASG091

1 1/16" x 3 3/4"

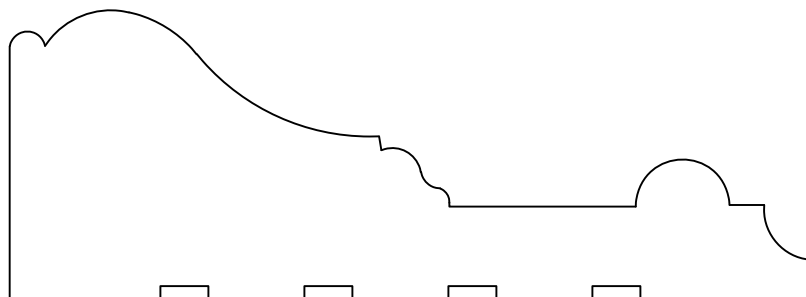

CASG090

1 1/2" x 4 3/16"

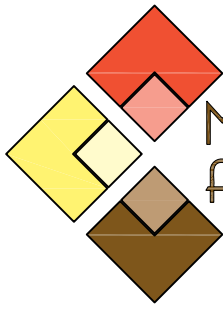

Melbourne  
Architectural  
MILLWORK COMPANY

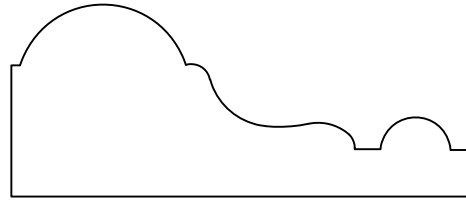

CASG093

1" x 2 3/8

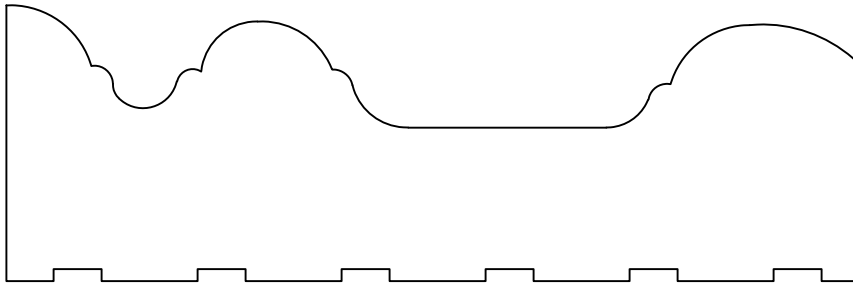

CASG092

1 7/16" x 4 7/16"

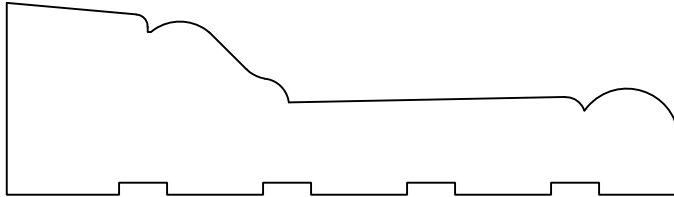

CASG094

1" x 3 1/2"

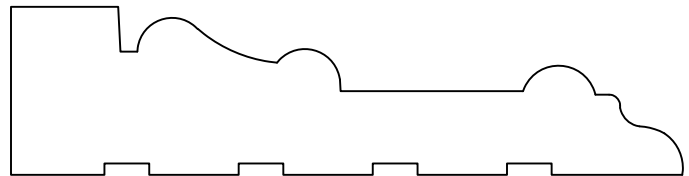

CASG096

7/8" x 3 1/2"

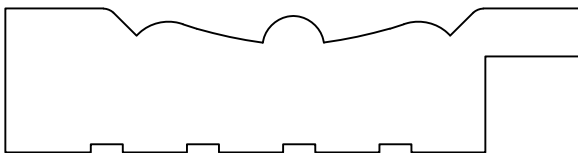

CASG095

3/4" x 3"



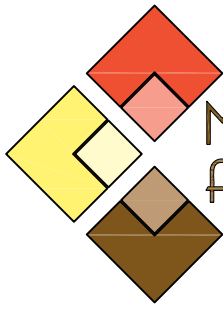

Melbourne  
Architectural  
MILLWORK COMPANY

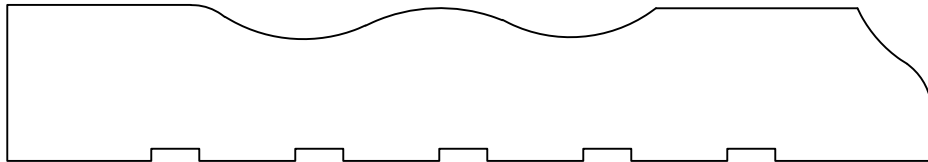

CASG097  
13/16" x 4 13/16"

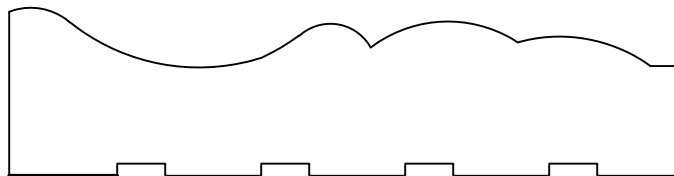

CASG098  
7/8" x 3 1/2"

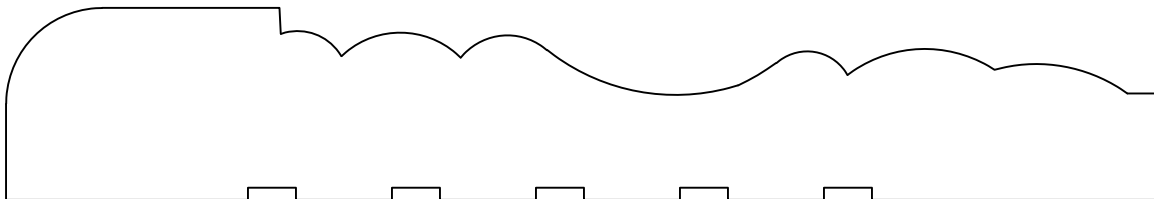

CASG099  
1" x 6"

325 East Drive - Melbourne, FL 32904  
321-308-3297 - Fax 321-308-3299

B25

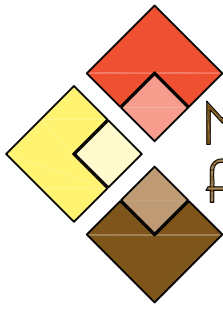

Melbourne  
Architectural  
MILLWORK COMPANY

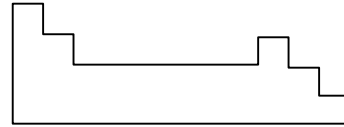

CASG101  
5/8" x 1 3/4"

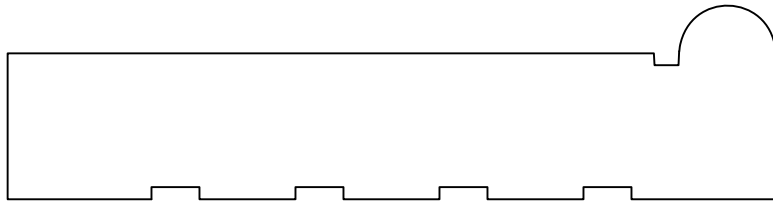

CASG100  
1" x 4"

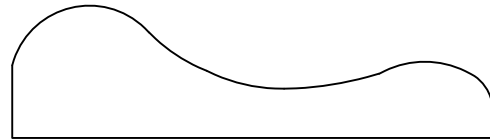

CASG103  
11/16" x 2 1/2"

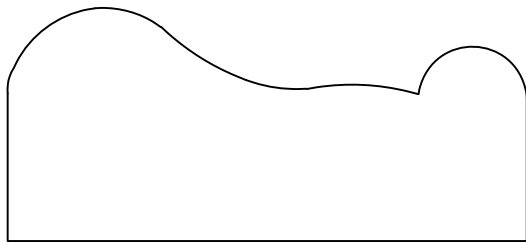

CASG102  
1 3/16" x 2 3/4"

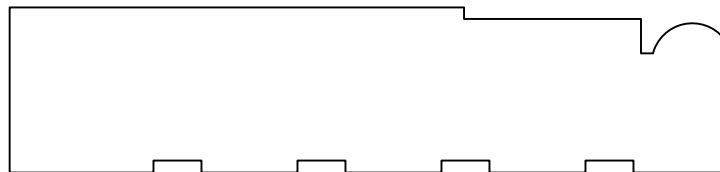

CASG104  
7/8" x 3 3/4"

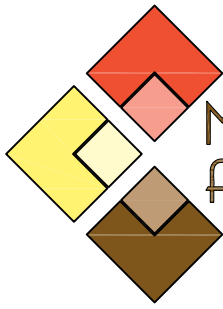

Melbourne  
Architectural  
MILLWORK COMPANY

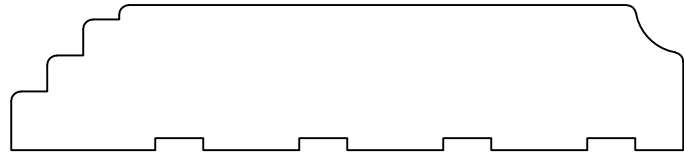

CASG105  
3/4" x 3 1/2"

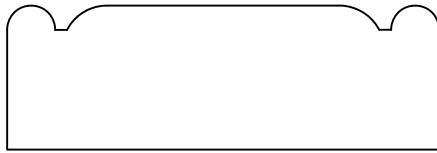

CASG106  
3/4" x 2 1/4"

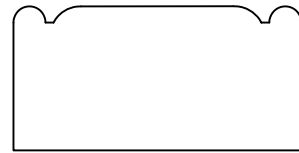

CASG107  
3/4" x 1 1/2"

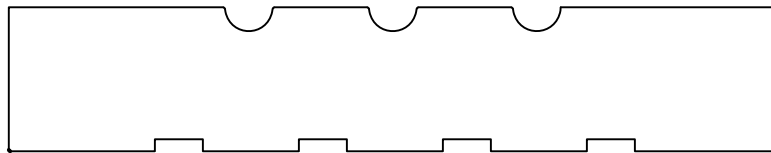

CASG108  
3/4" x 4"

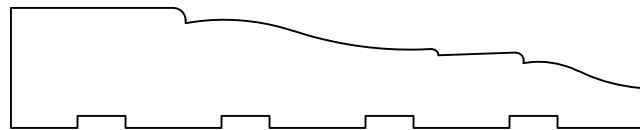

CASG109  
5/8" x 3 5/16"

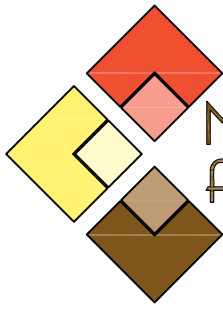

Melbourne  
Architectural  
MILLWORK COMPANY

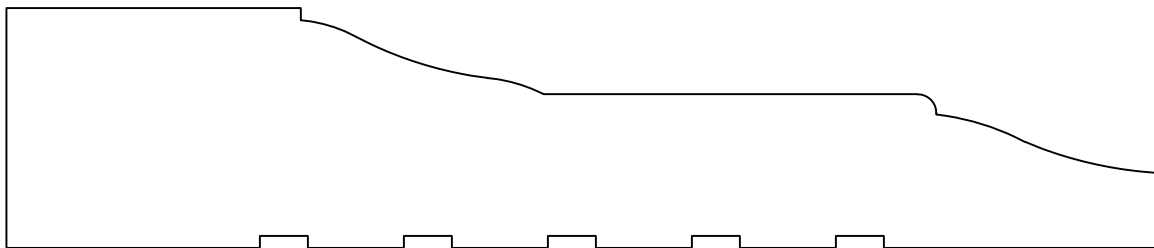

CASG110  
1 1/4" x 6"

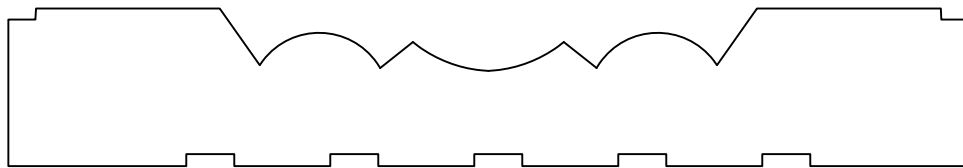

CASG111  
13/16" x 5"

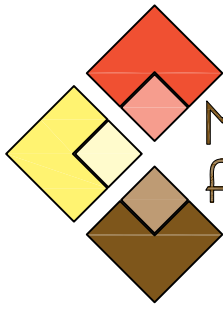

Melbourne  
Architectural  
MILLWORK COMPANY

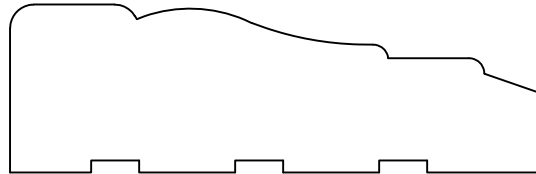

CASG112  
7/8" x 2 3/4"

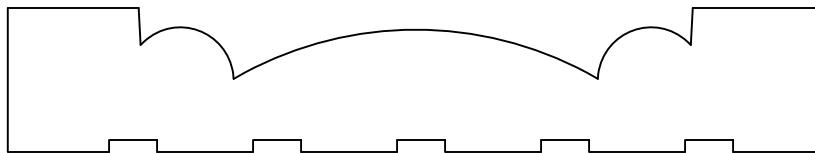

CASG113  
3/4" x 4 1/4"

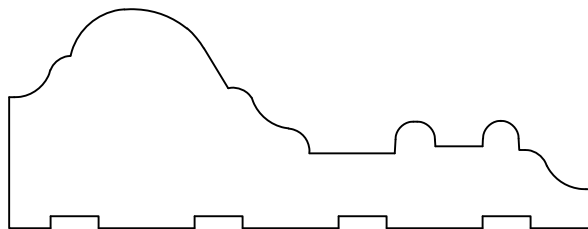

CASG114  
1 1/8" x 3 1/16"

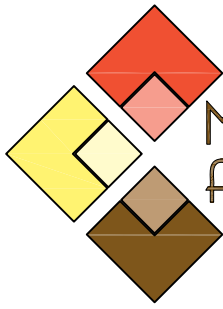

Melbourne  
Architectural  
MILLWORK COMPANY

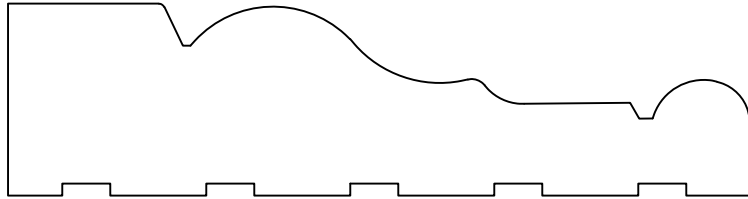

CASG115  
1" x 3 7/8"

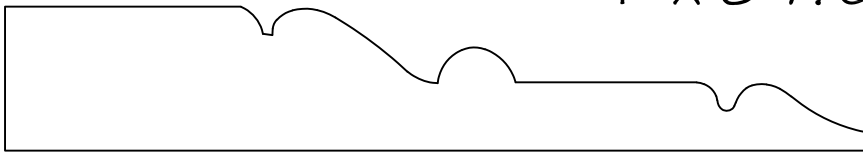

CASG116  
3/4" x 4 1/2"



CASG117  
5/8" x 3 9/16"

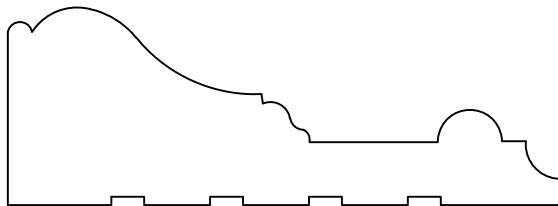

CASG118  
1" x 2 7/8"

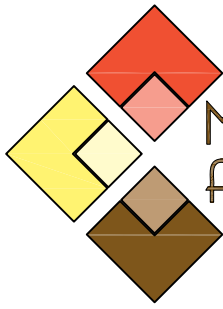

Melbourne  
Architectural  
MILLWORK COMPANY

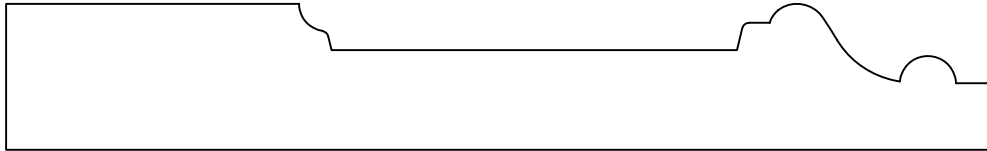

CASG119  
3/4" x 5 3/16"

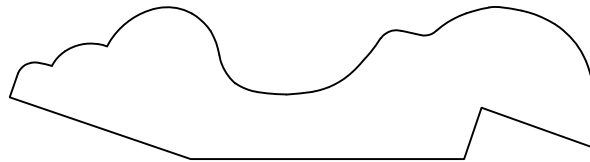

CASG120  
3/4" x 3 1/16"

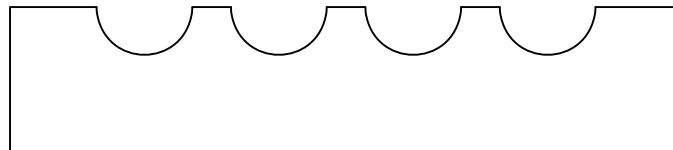

CASG121  
3/4" x 3 1/2"

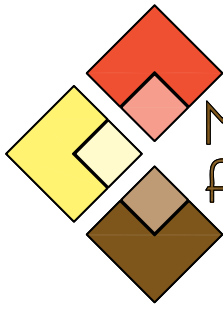

Melbourne  
Architectural  
MILLWORK COMPANY

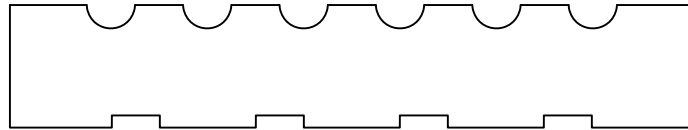

CASG122  
5/8" x 3 9/16"

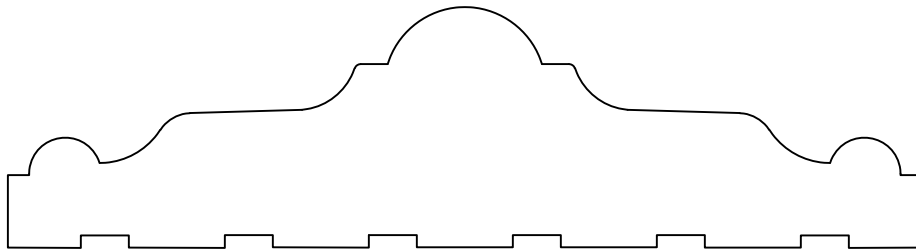

CASG123  
1 1/4" x 4 3/4"

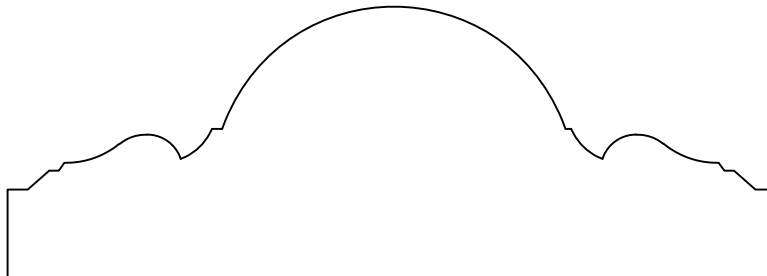

CASG124  
1 1/2" x 4"



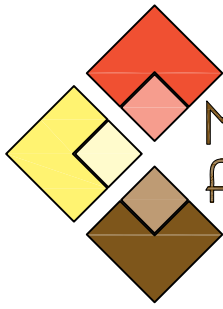

Melbourne  
Architectural  
MILLWORK COMPANY

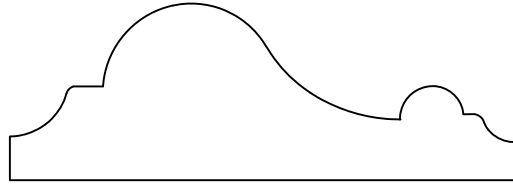

CASG125  
15/16" x 2 9/16"



CASG126  
1 3/16" x 4 3/4"

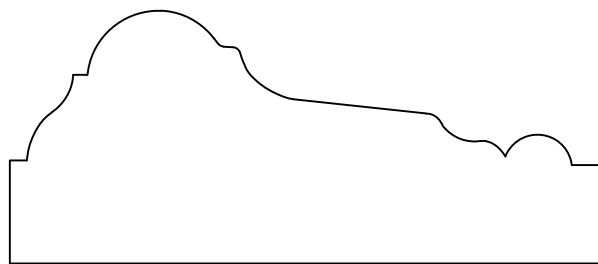

CASG127  
1 5/16" x 3 1/8"

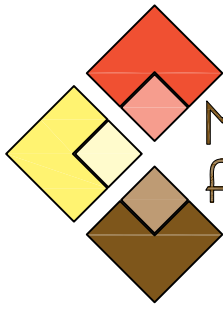

Melbourne  
Architectural  
MILLWORK COMPANY

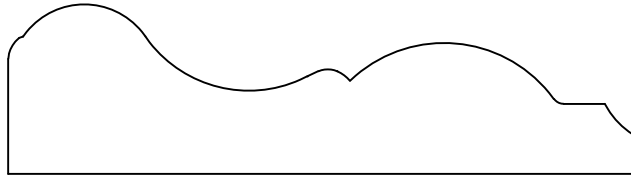

CASG128  
3/4" x 3 1/4"

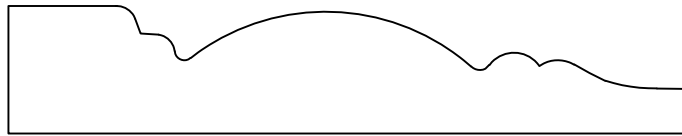

CASG129  
5/8" x 3 1/2"



CASG130  
13/16" x 3 1/2"

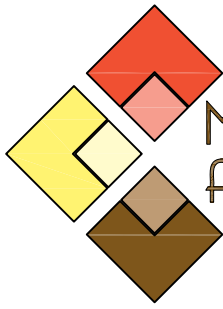

Melbourne  
Architectural  
MILLWORK COMPANY



CASG131  
5/8" x 4"

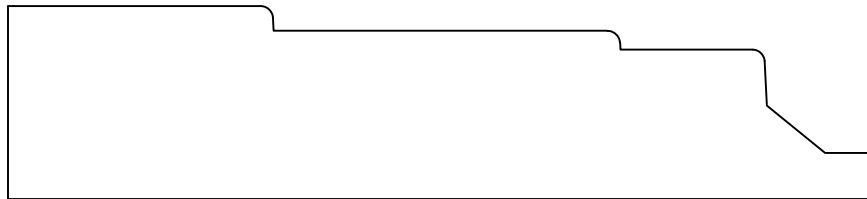

CASG132  
1" x 4 1/2"

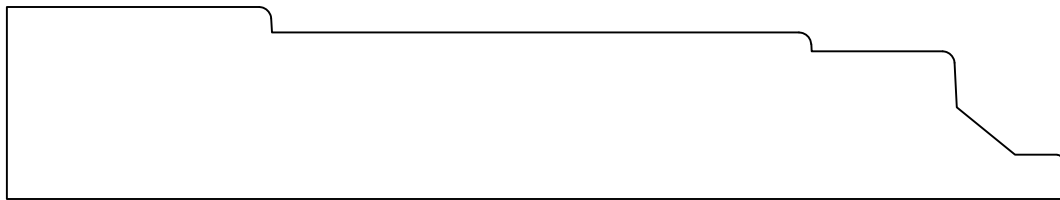

CASG133  
1" x 5 1/2"

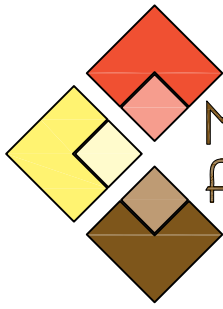

Melbourne  
Architectural  
MILLWORK COMPANY

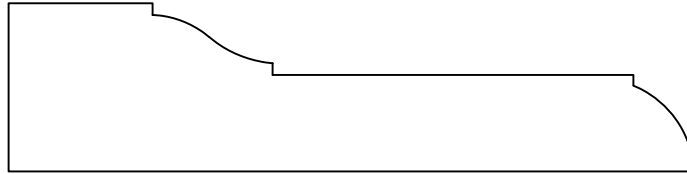

CASG134  
7/8" x 3 9/16"

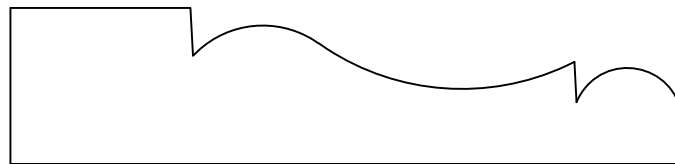

CASG135  
13/16" x 3 1/2"

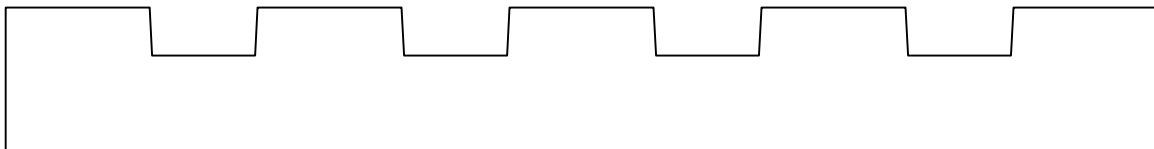

CASG136  
3/4" x 6"

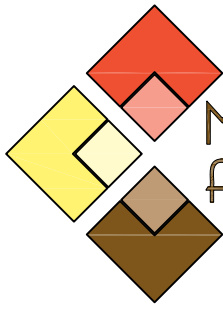

Melbourne  
Architectural  
MILLWORK COMPANY

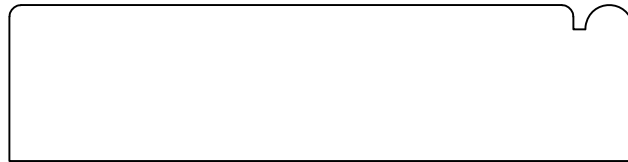

CASG137  
13/16" x 3 1/4"

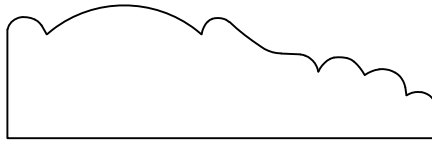

CASG138  
11/16" x 2 1/4"



CASG139  
1" x 5"

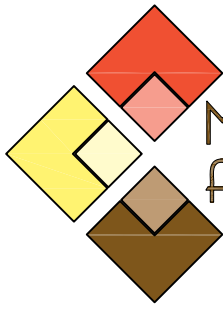

Melbourne  
Architectural  
MILLWORK COMPANY

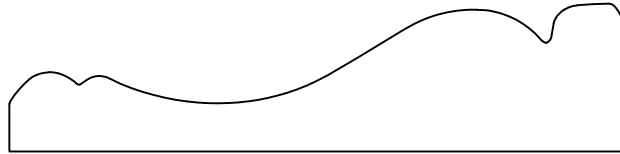

CASG140  
3/4" x 3 3/16"

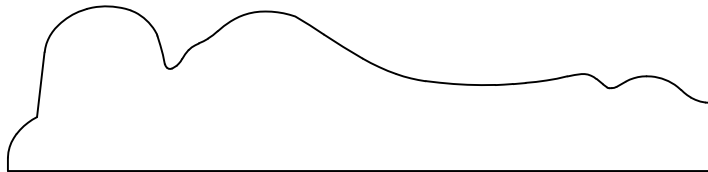

CASG141  
7/8" x 3 11/16"

RESERVED FOR  
CASG142

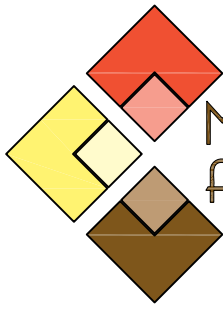

Melbourne  
Architectural  
MILLWORK COMPANY

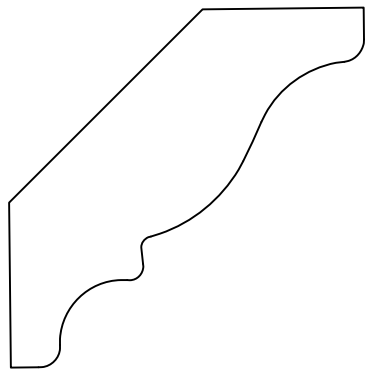

CRWN001  
3/4" X 2 5/8"

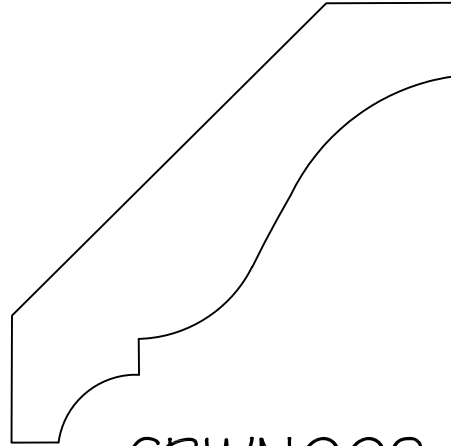

CRWN002  
3/4" X 3 1/4"

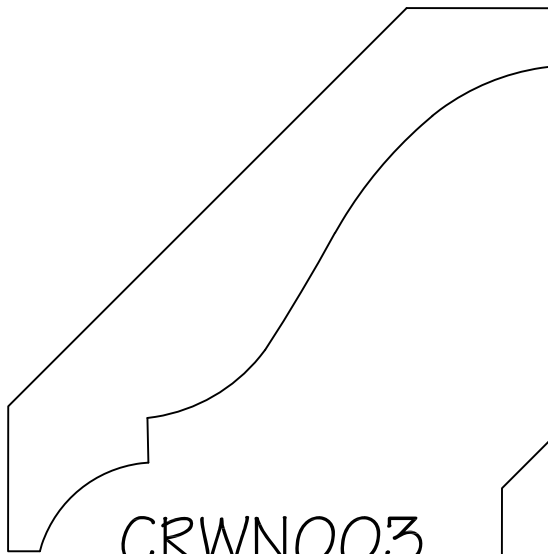

CRWN003  
3/4" X 4"

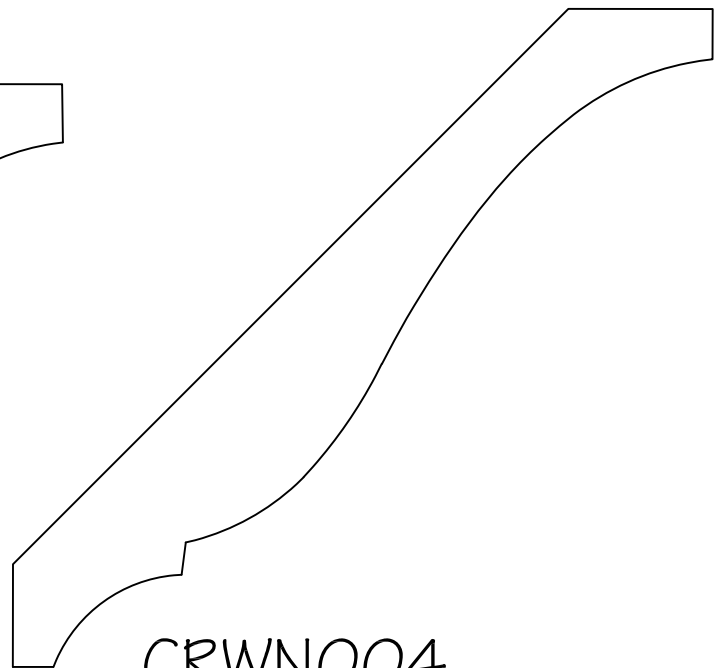

CRWN004  
3/4" X 5"

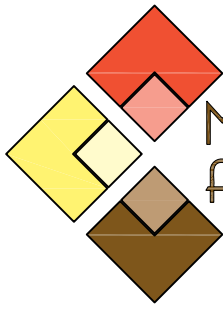

Melbourne  
Architectural  
MILLWORK COMPANY

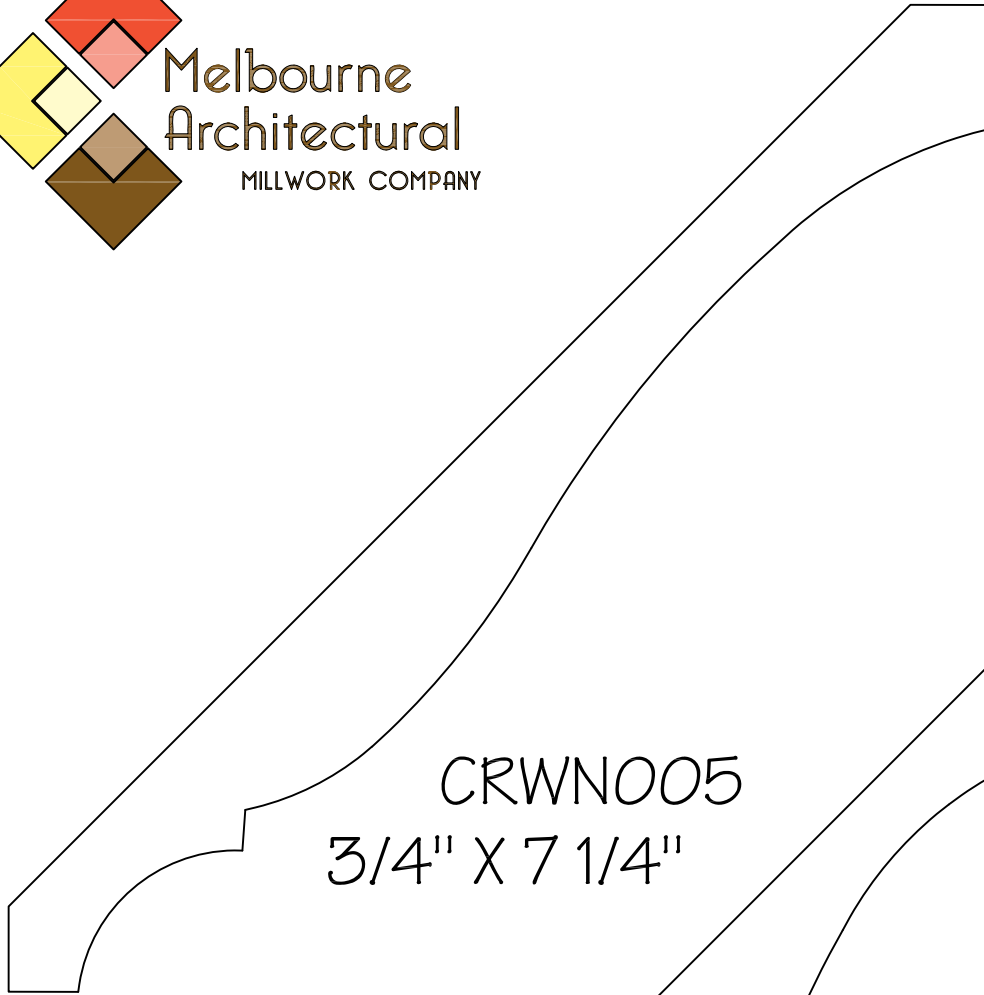

CRWN005  
3/4" X 7 1/4"

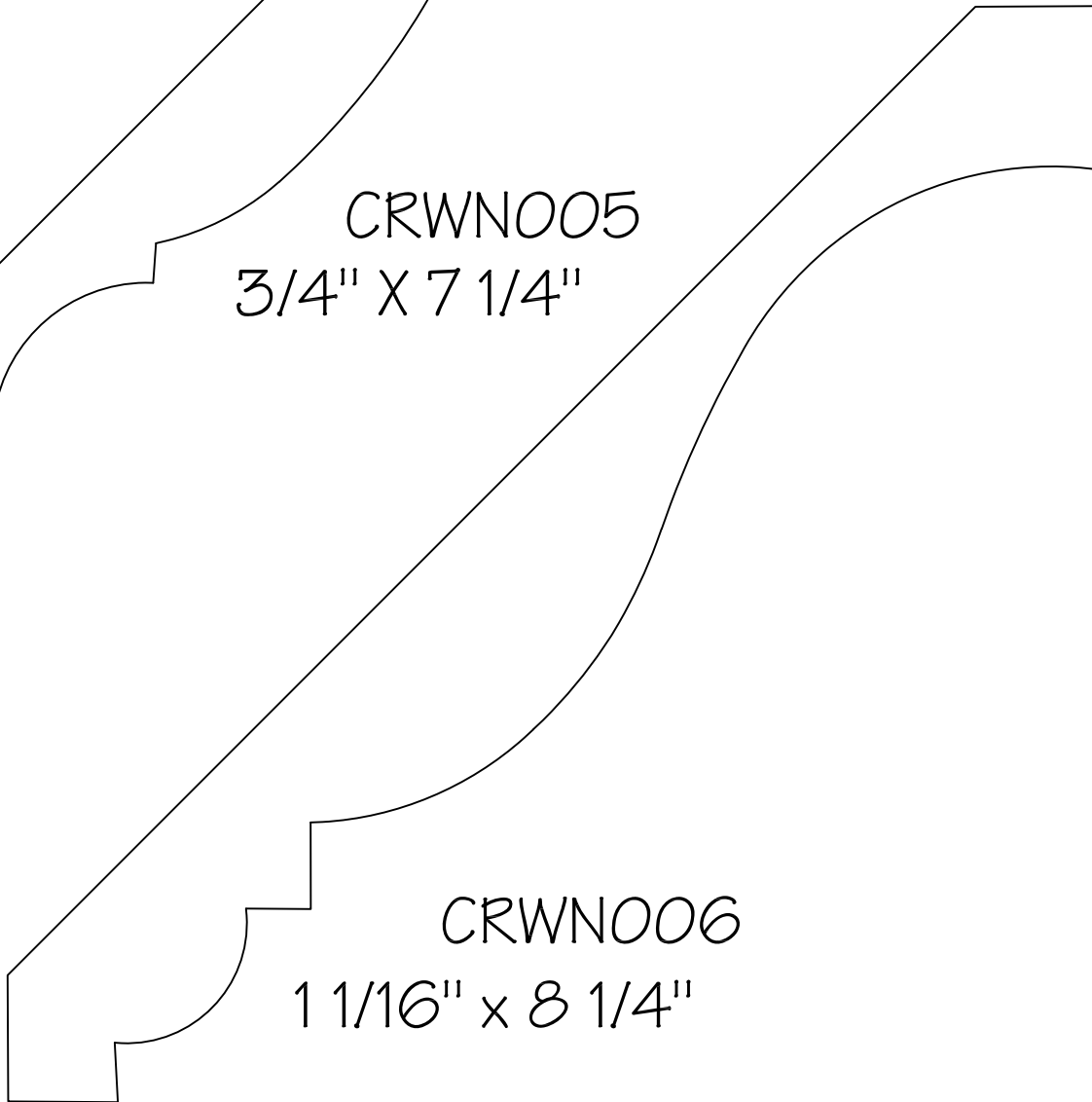

CRWN006  
1 1/16" X 8 1/4"

C02

325 East Drive - Melbourne, FL 32904  
321-308-3297 - Fax 321-308-3299



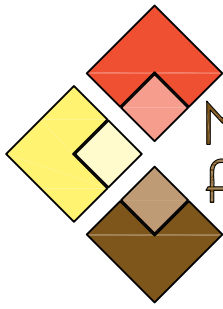

Melbourne  
Architectural  
MILLWORK COMPANY



CRWN007  
7/8" X 6 1/2"

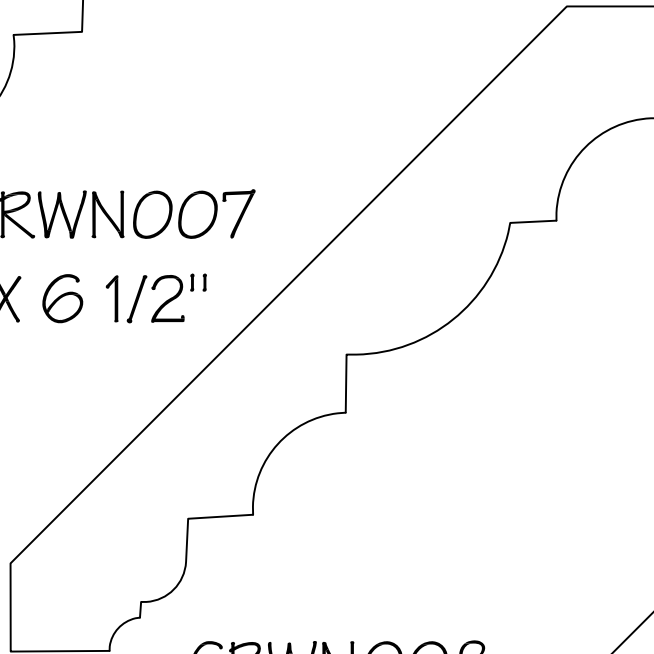

CRWN008  
3/4" X 4 3/4"

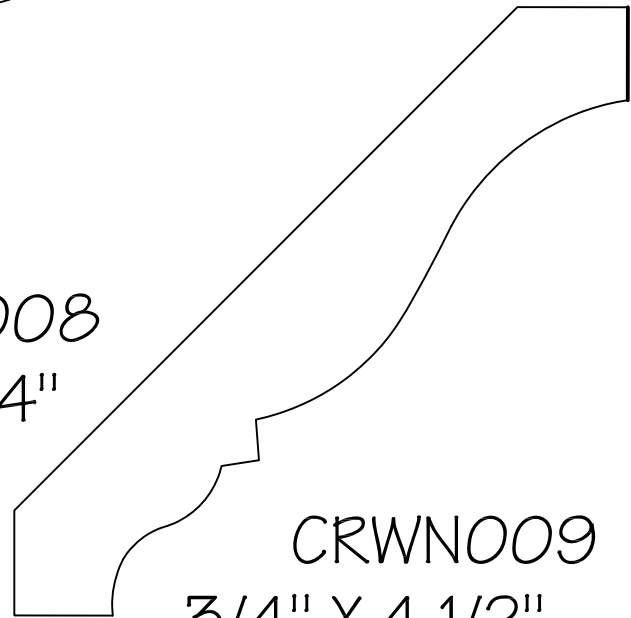

CRWN009  
3/4" X 4 1/2"

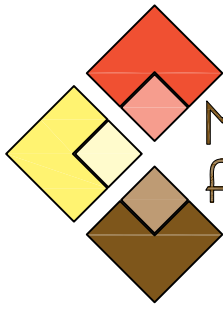

Melbourne  
Architectural  
MILLWORK COMPANY

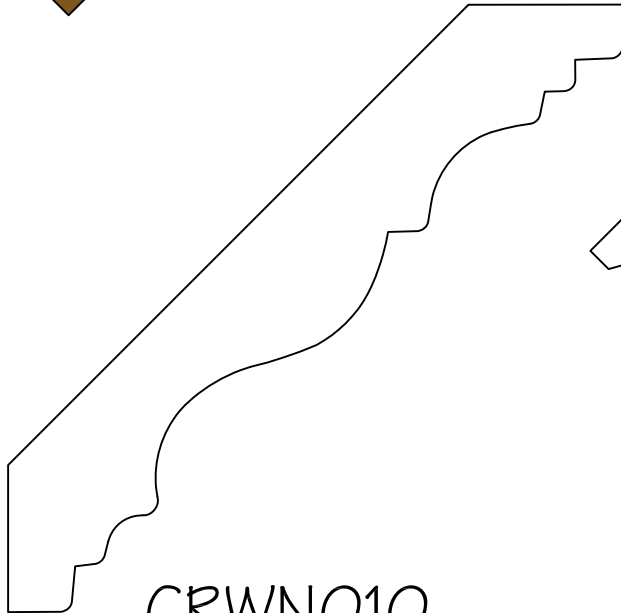

CRWNO10  
3/4" X 4 1/2"

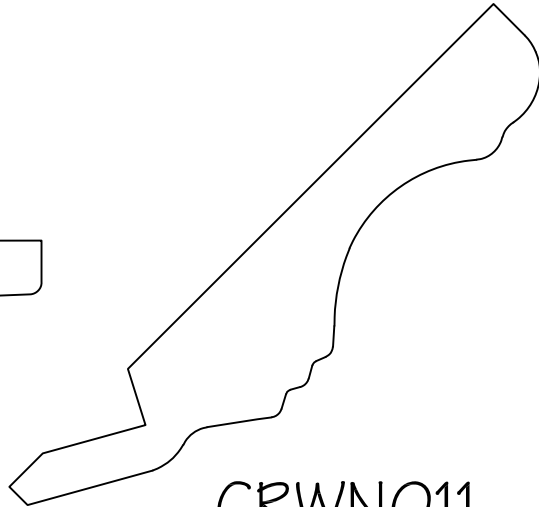

CRWNO11  
23/32" X 3 9/16"

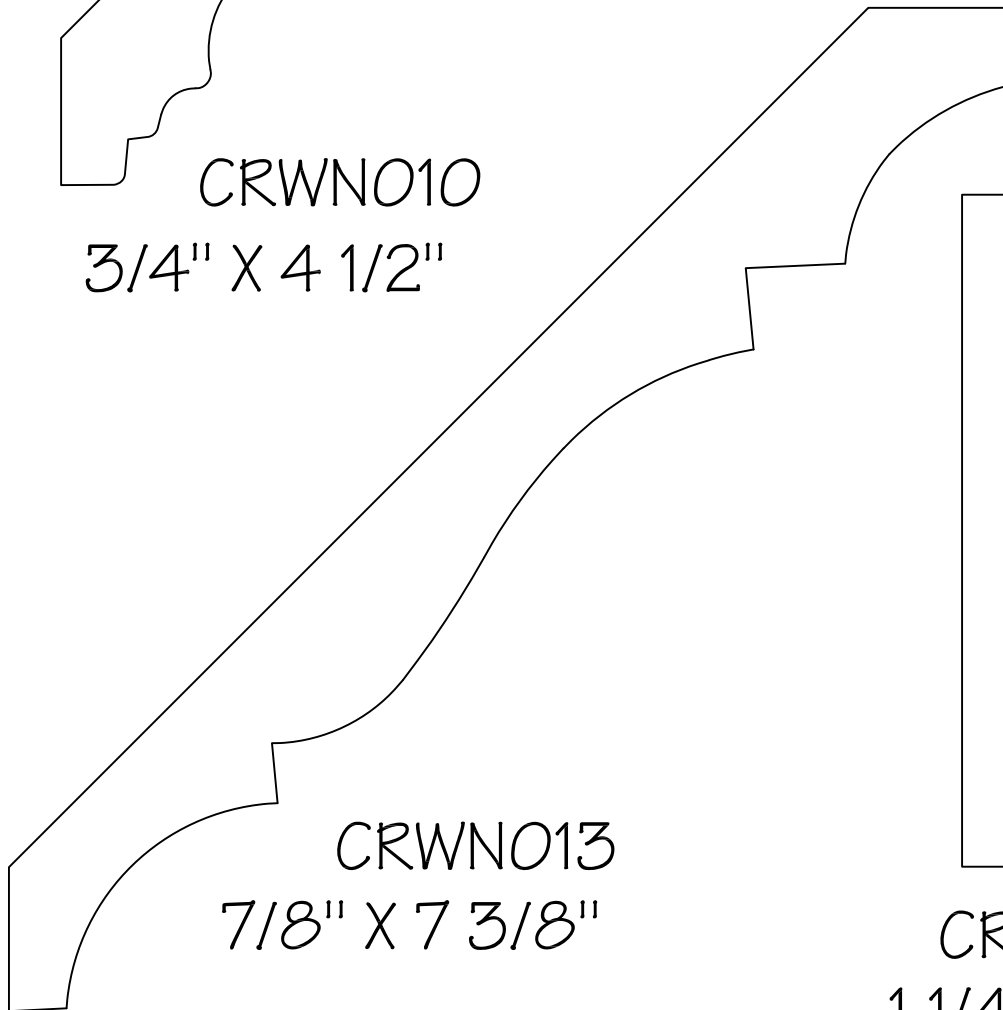

CRWNO13  
7/8" X 7 3/8"

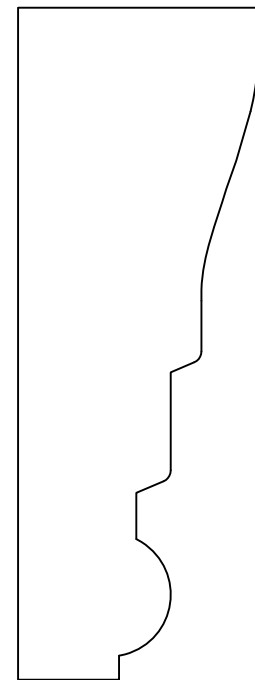

CRWNO12  
1 1/4" X 3 1/2"

C04

325 East Drive - Melbourne, FL 32904  
321-308-3297 - Fax 321-308-3299

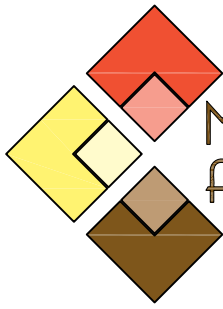

Melbourne  
Architectural  
MILLWORK COMPANY

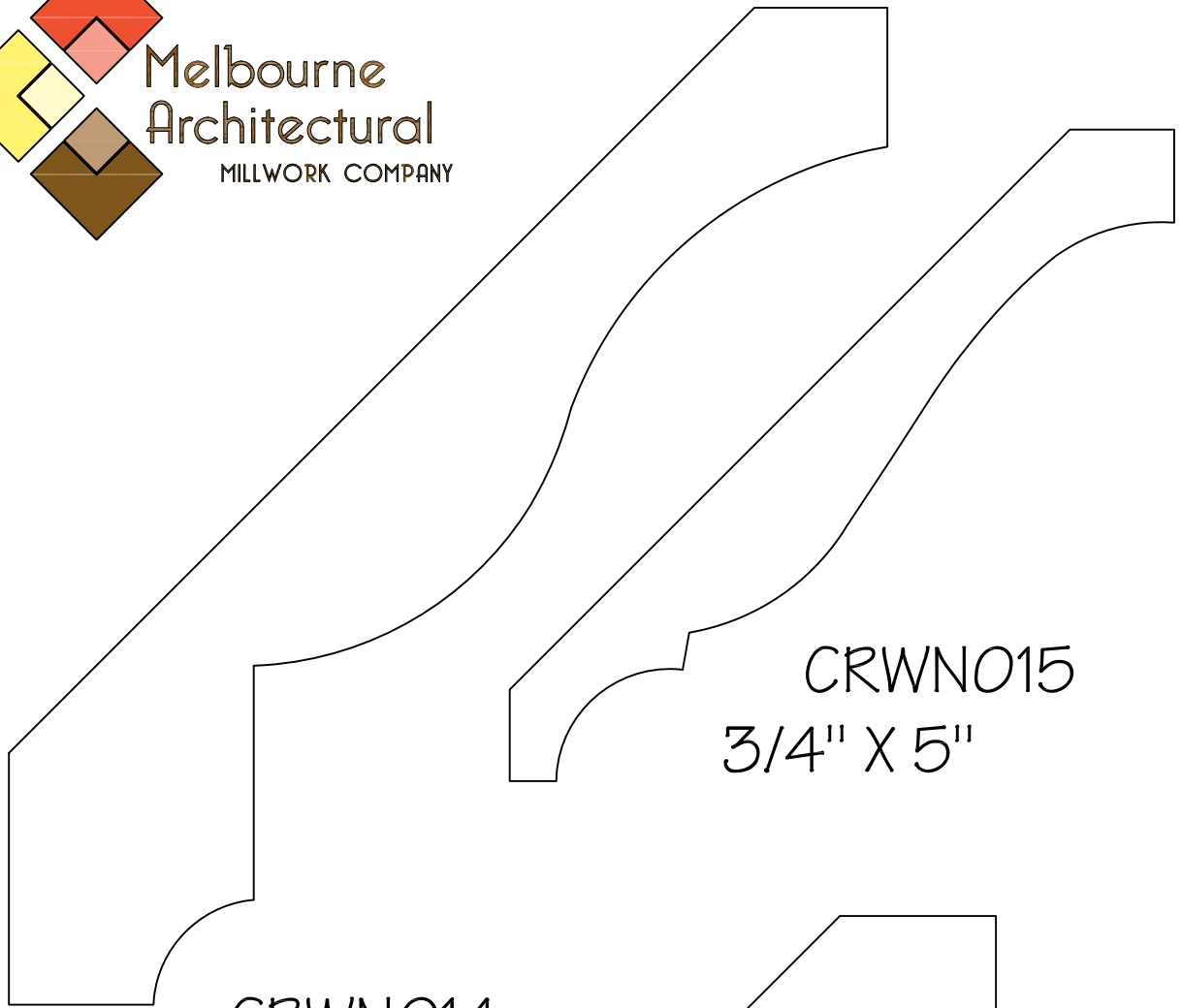

CRWNO15  
3/4" X 5"

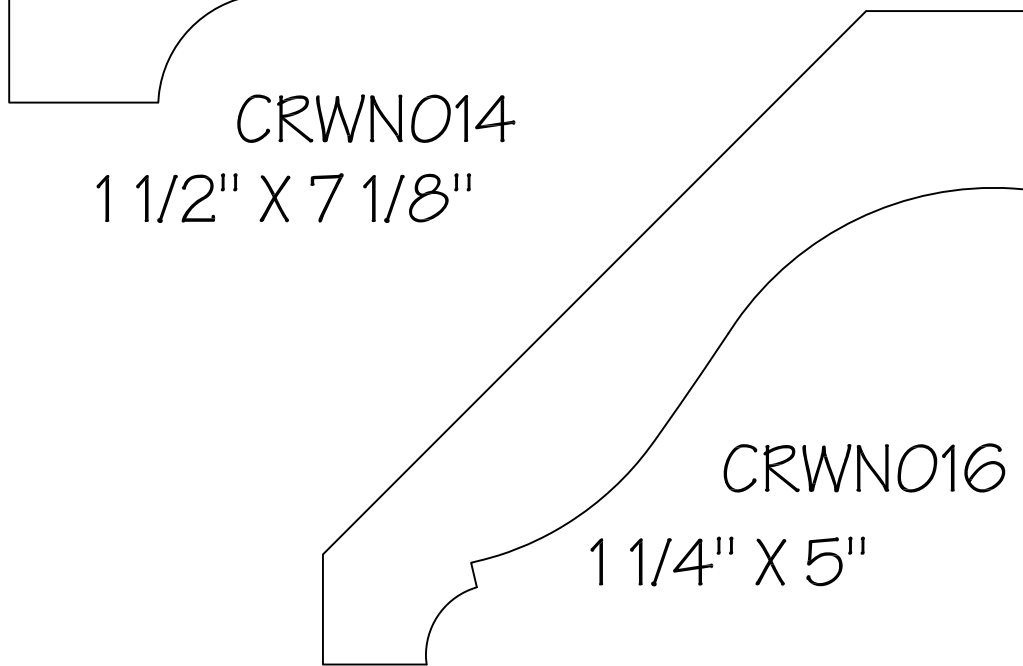

CRWNO14  
1 1/2" X 7 1/8"

CRWNO16  
1 1/4" X 5"

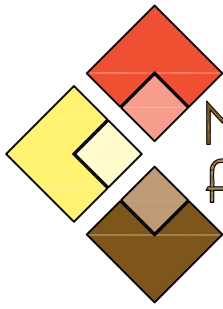

Melbourne  
Architectural  
MILLWORK COMPANY

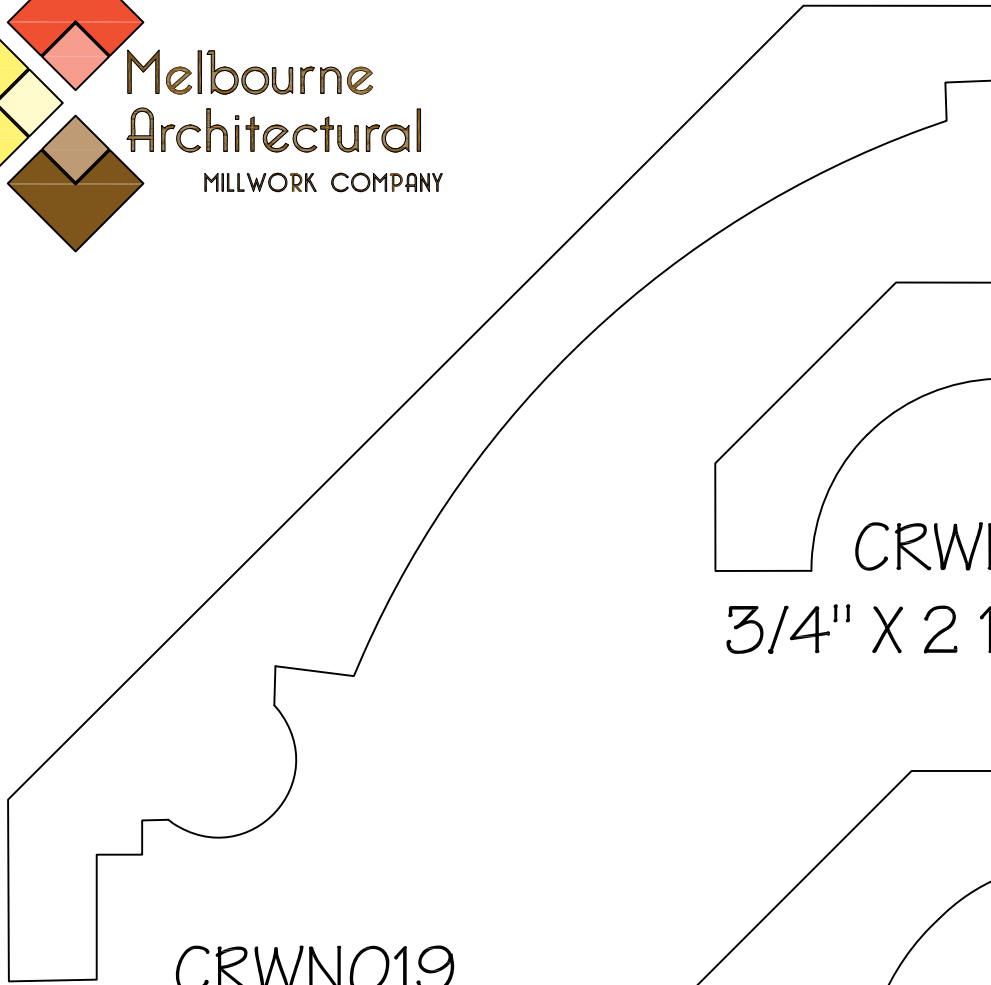

CRWNO19

1 1/16" X 7 1/4"

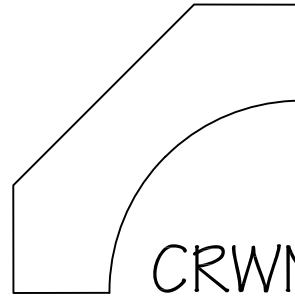

CRWNO17

3/4" X 2 1/8"

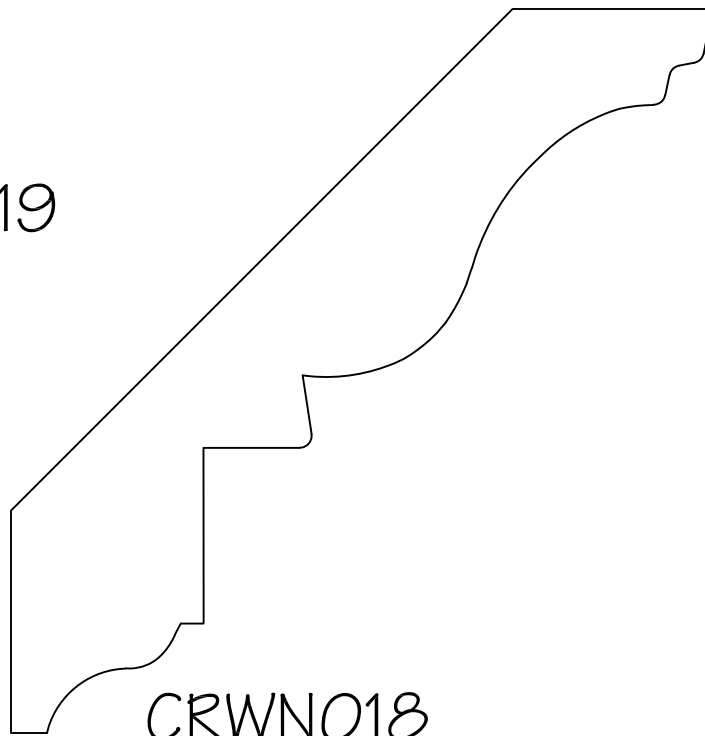

CRWNO18

1 1/8" X 5 1/4"

C06

325 East Drive - Melbourne, FL 32904  
321-308-3297 - Fax 321-308-3299

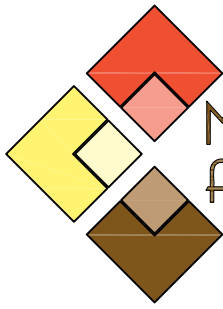

Melbourne  
Architectural  
MILLWORK COMPANY

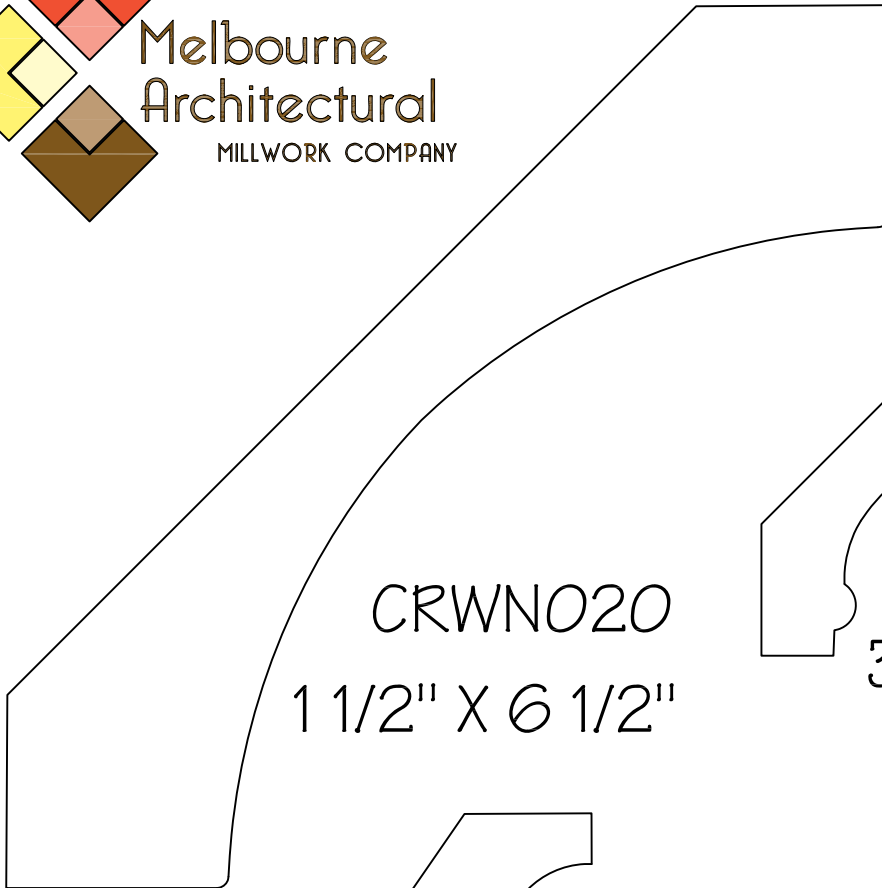

CRWNO20  
1 1/2" X 6 1/2"

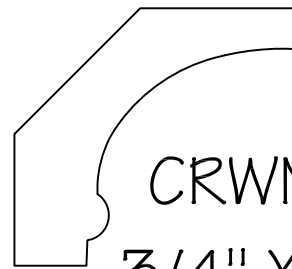

CRWNO23  
3/4" X 2"

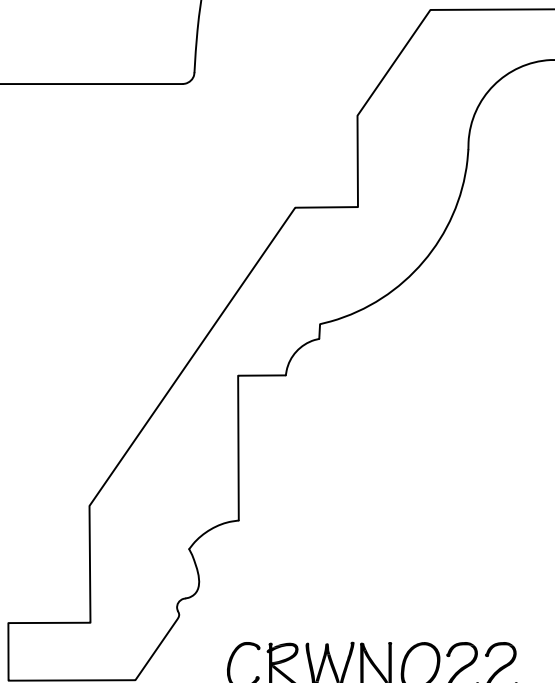

CRWNO22  
23/32" X 4 1/2"

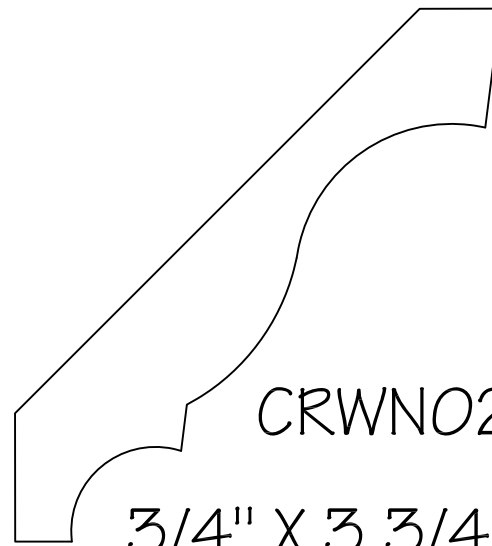

CRWNO21  
3/4" X 3 3/4"

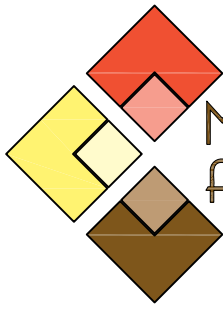

Melbourne  
Architectural  
MILLWORK COMPANY

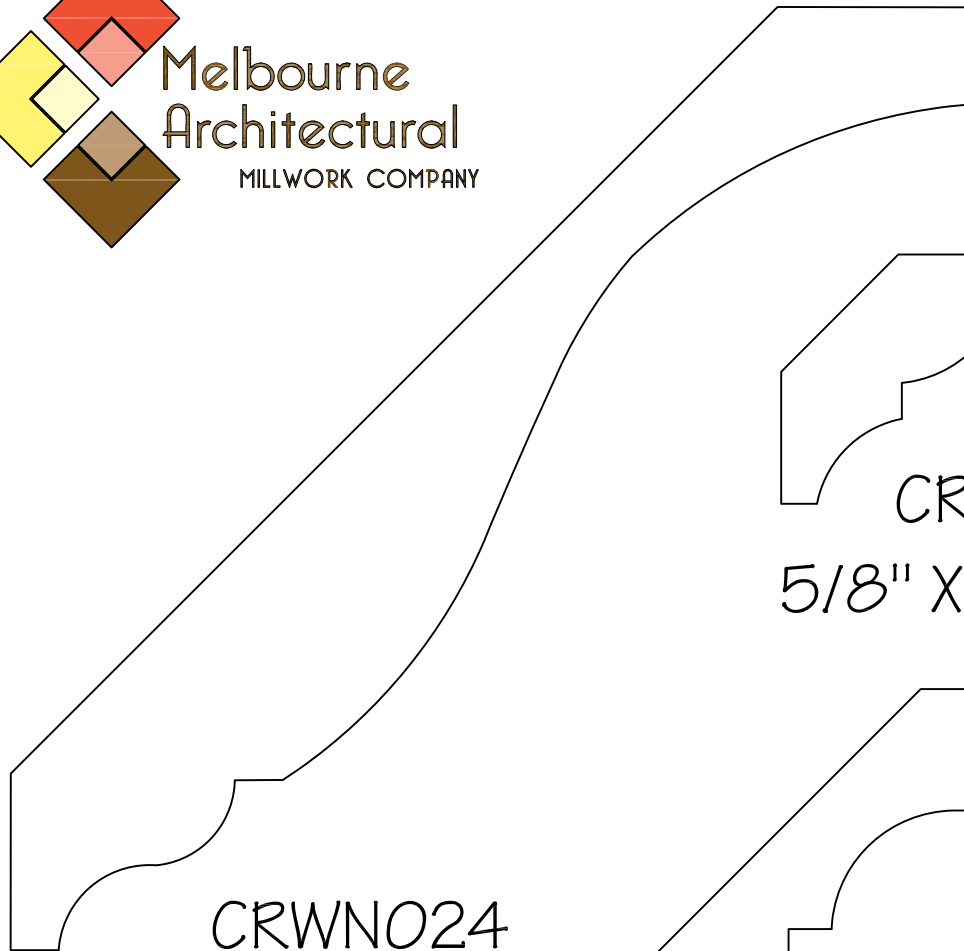

CRWNO24

1 1/16" X 7"

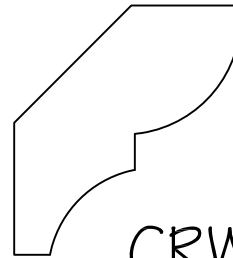

CRWNO25

5/8" X 1 3/4"

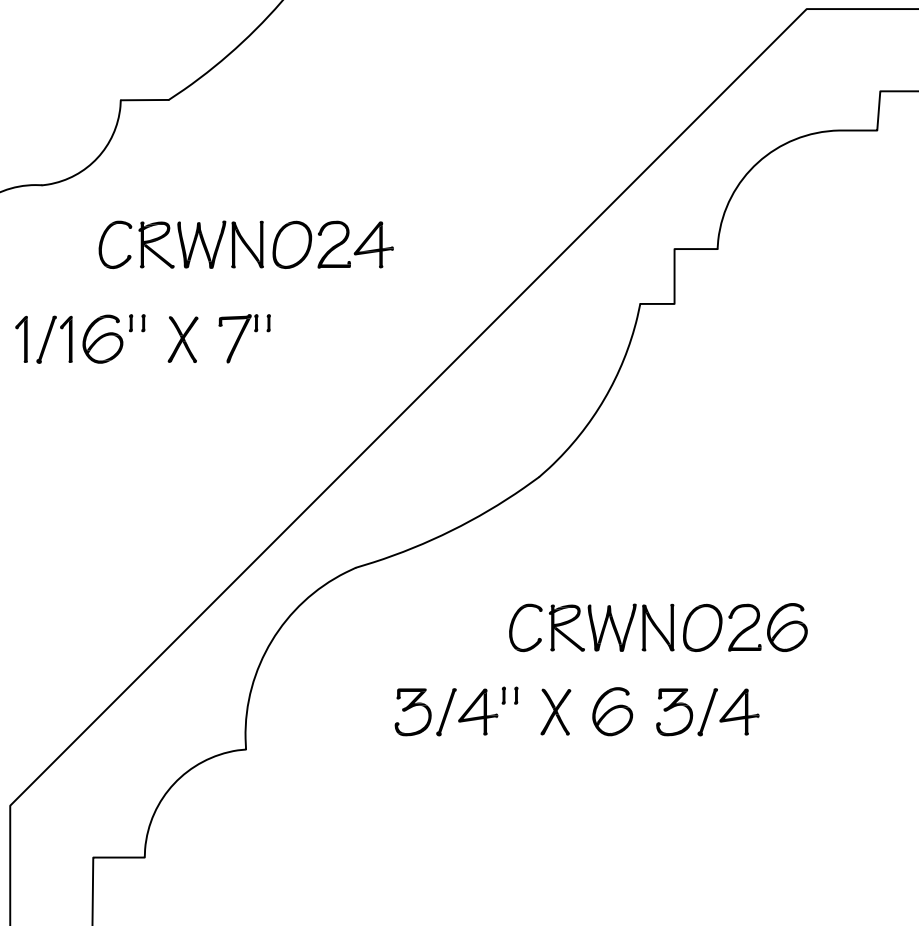

CRWNO26

3/4" X 6 3/4"

C08

325 East Drive - Melbourne, FL 32904  
321-308-3297 - Fax 321-308-3299

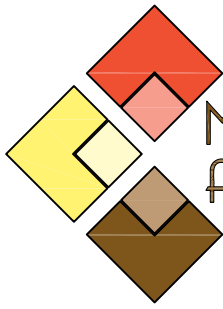

Melbourne  
Architectural  
MILLWORK COMPANY

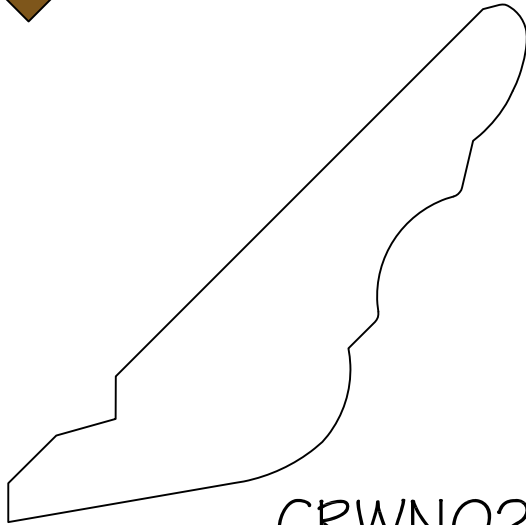

CRWNO27

1" X 3 3/4"

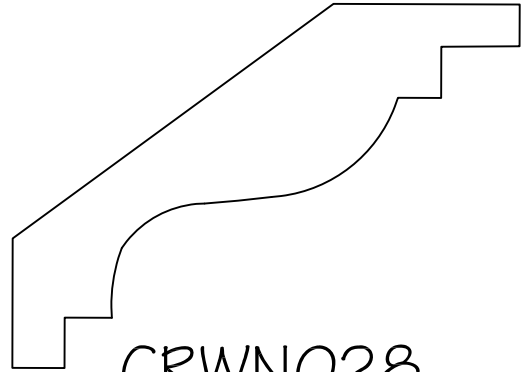

CRWNO28

3/4" X 3 1/4"

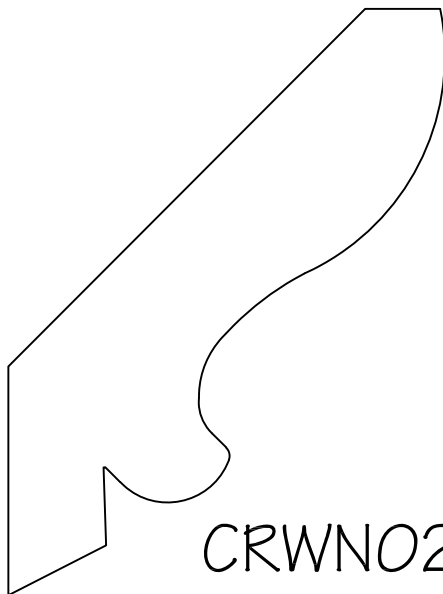

CRWNO29

1 3/16" X 3 3/4"

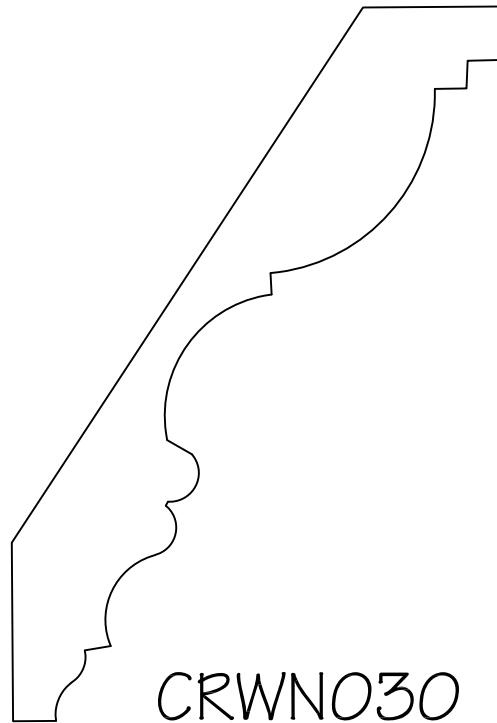

CRWNO30

3/4" X 4 1/2"

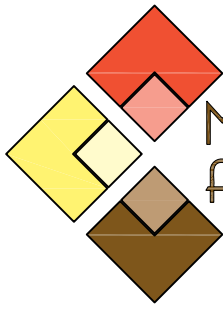

Melbourne  
Architectural  
MILLWORK COMPANY

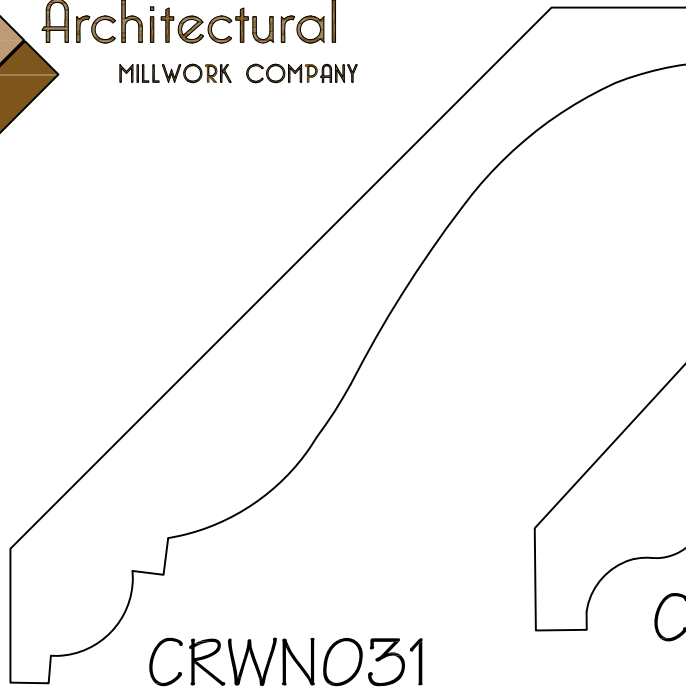

CRWNO31

3/4" X 5"

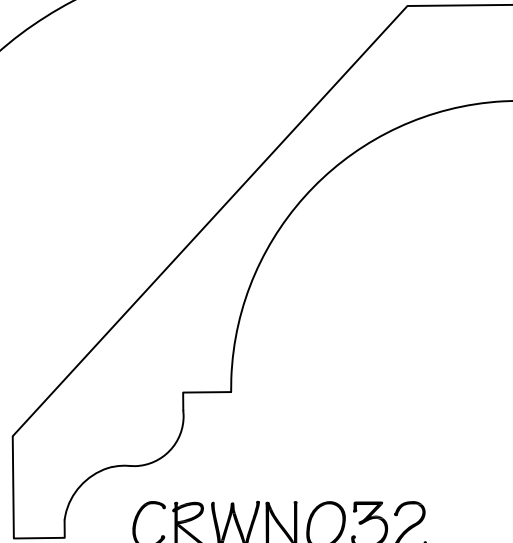

CRWNO32

3/4" X 3 13/16"

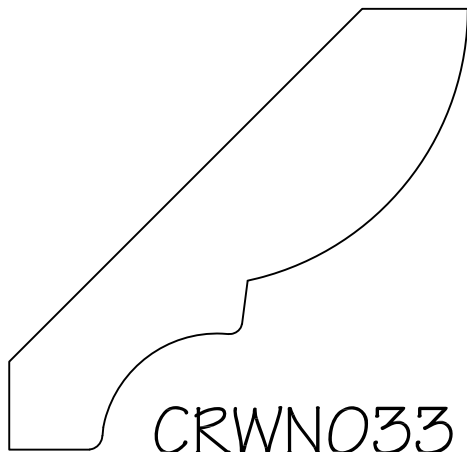

CRWNO33

13/16" X 3 5/16"

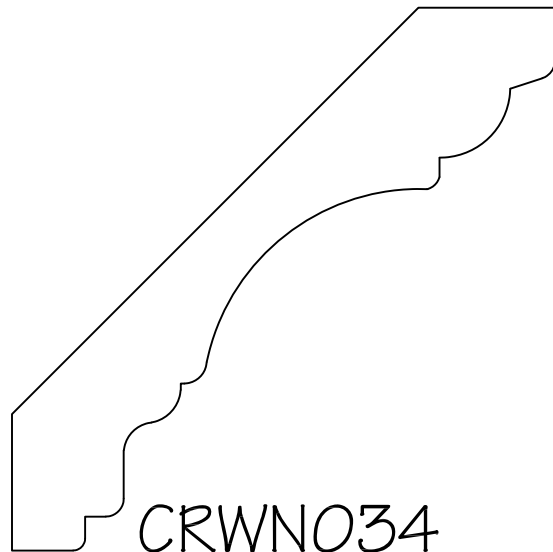

CRWNO34

3/4" X 4"



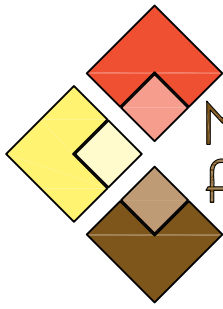

Melbourne  
Architectural  
MILLWORK COMPANY

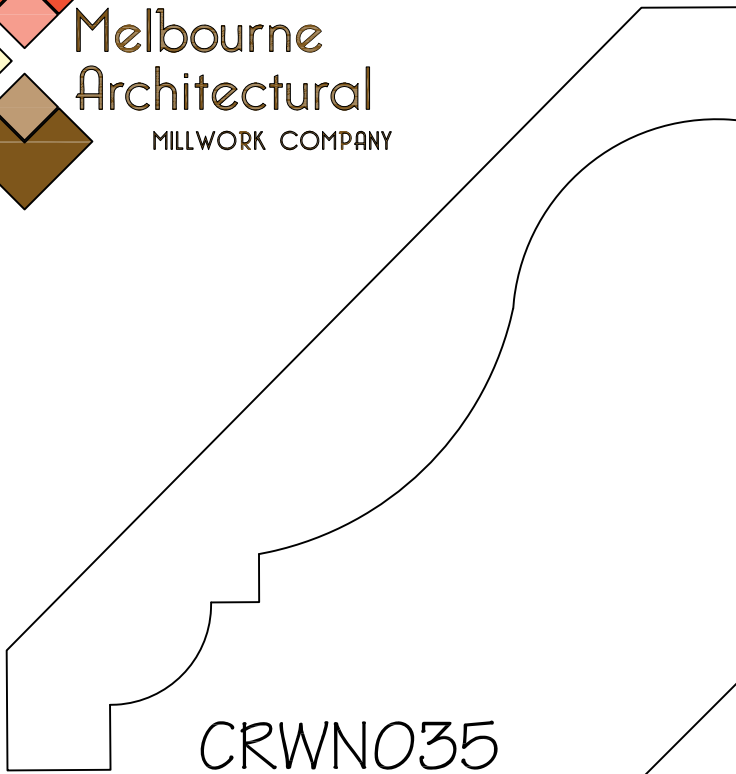

CRWNO35

7/8" X 5 1/2"

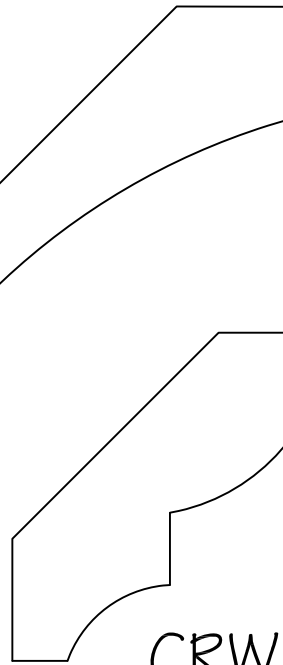

CRWNO37

3/4" X 2 3/8"

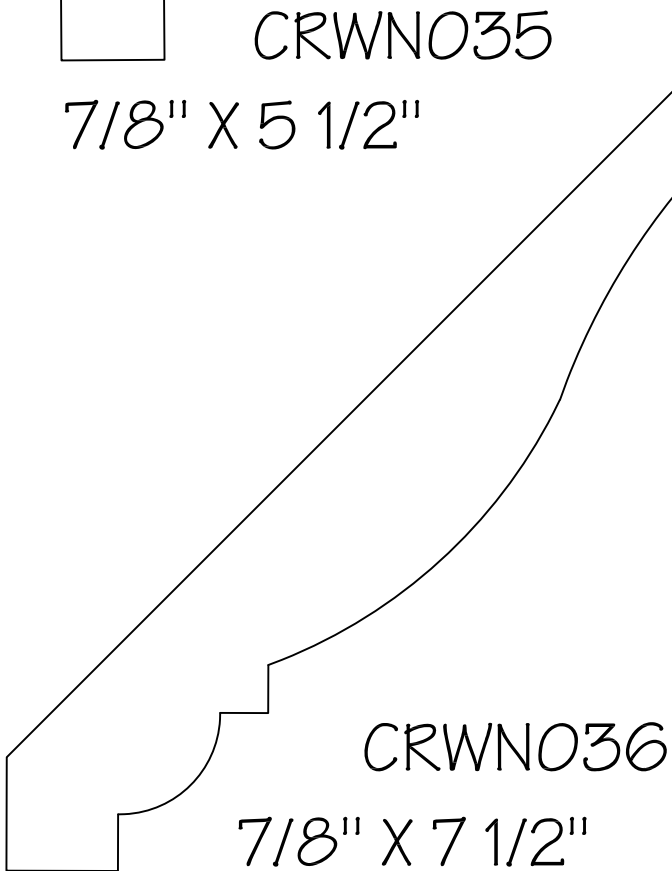

CRWNO36

7/8" X 7 1/2"

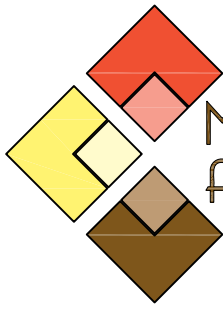

Melbourne  
Architectural  
MILLWORK COMPANY



CRWNO38

1" x 5 1/4"

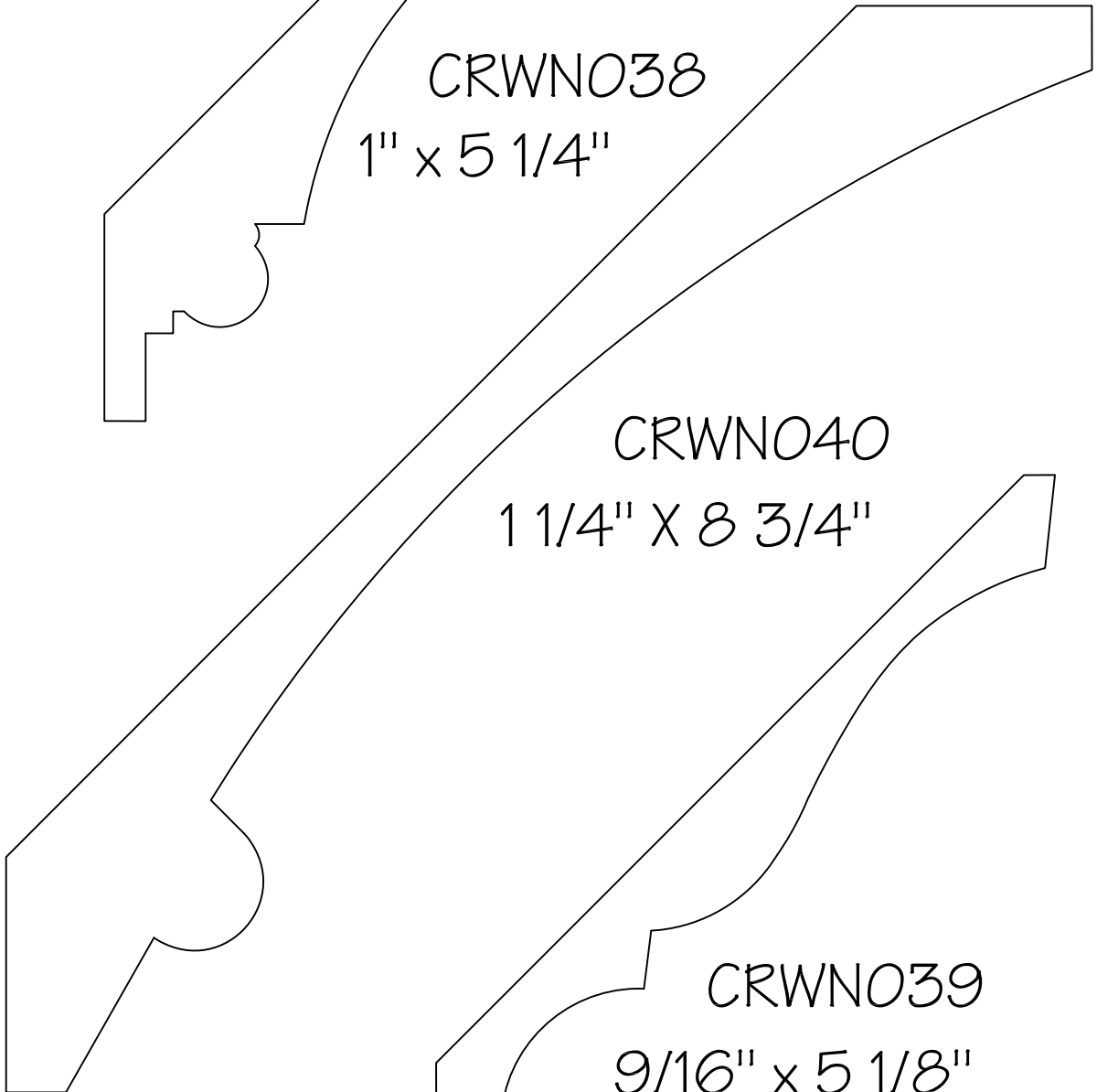

CRWNO40

1 1/4" x 8 3/4"

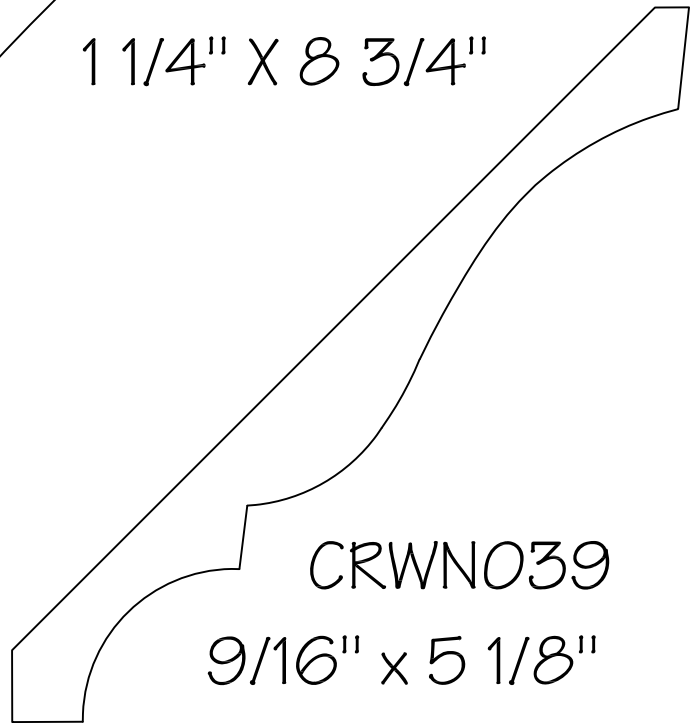

CRWNO39

9/16" x 5 1/8"

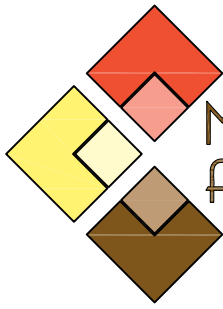

Melbourne  
Architectural  
MILLWORK COMPANY

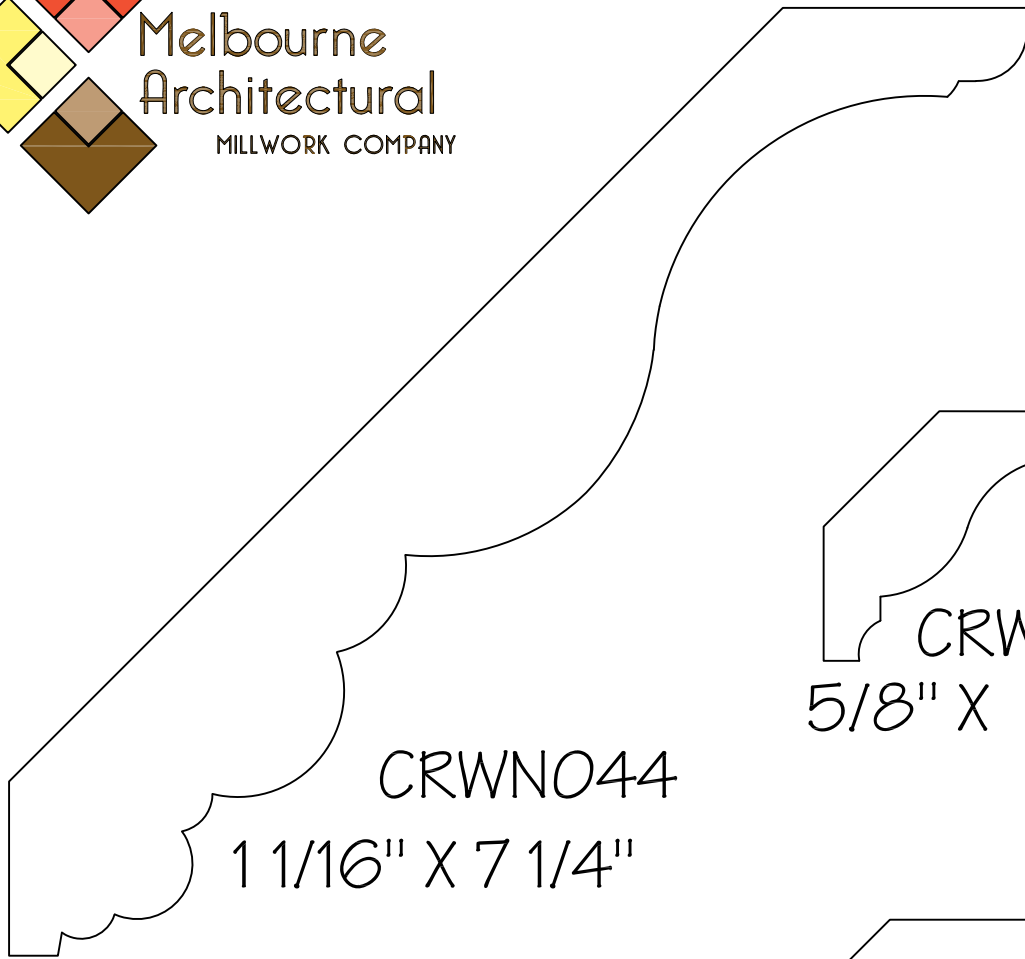

CRWNO44

1 1/16" X 7 1/4"

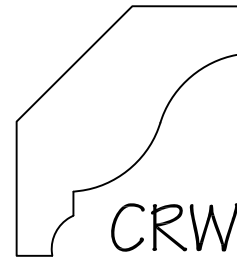

CRWNO41

5/8" X 1 3/4"

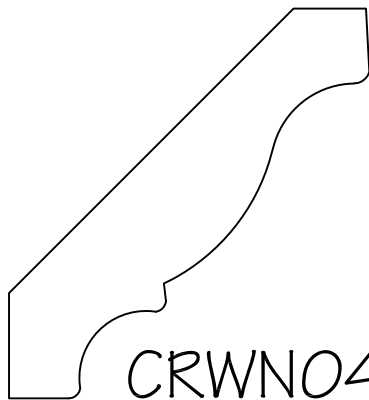

CRWNO42

5/8" X 2 3/4"

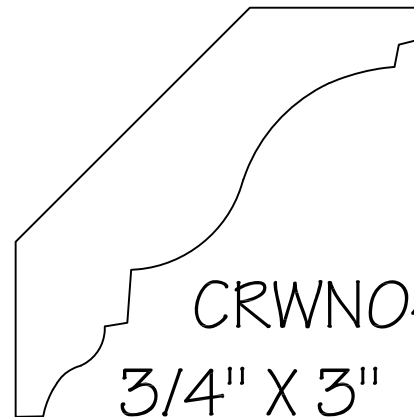

CRWNO43

3/4" X 3"

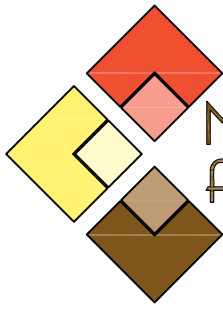

Melbourne  
Architectural  
MILLWORK COMPANY

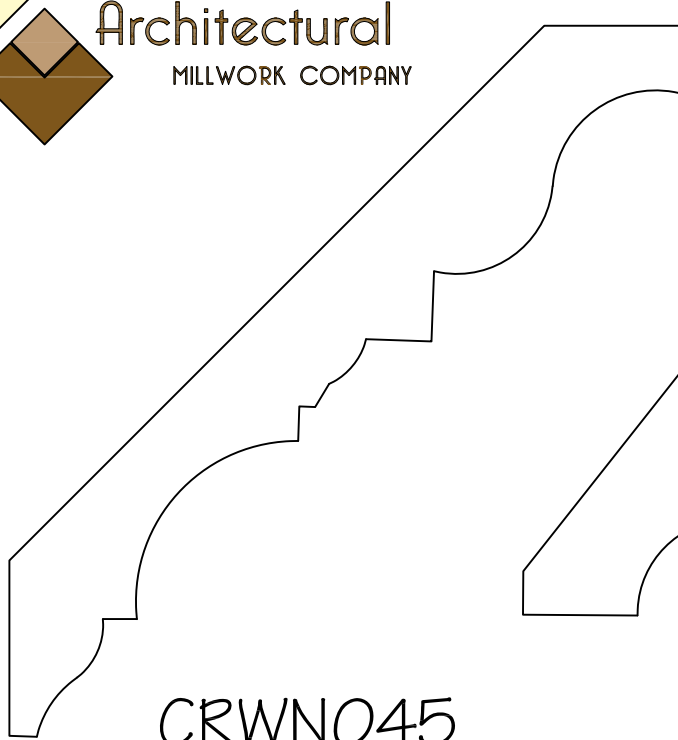

CRWNO45  
3/4" X 5 3/32"

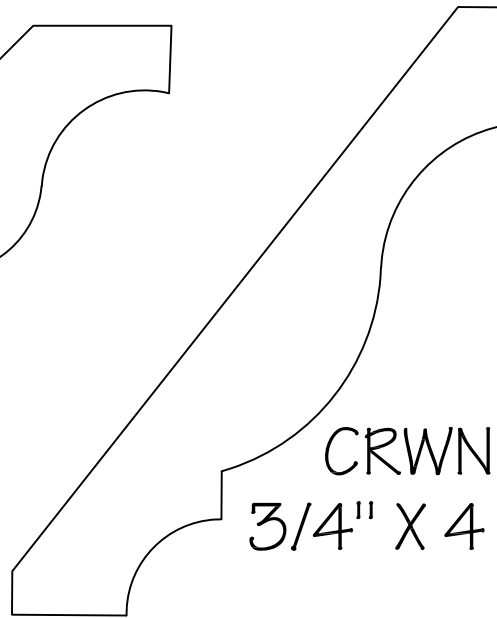

CRWNO47  
3/4" X 4 1/16"

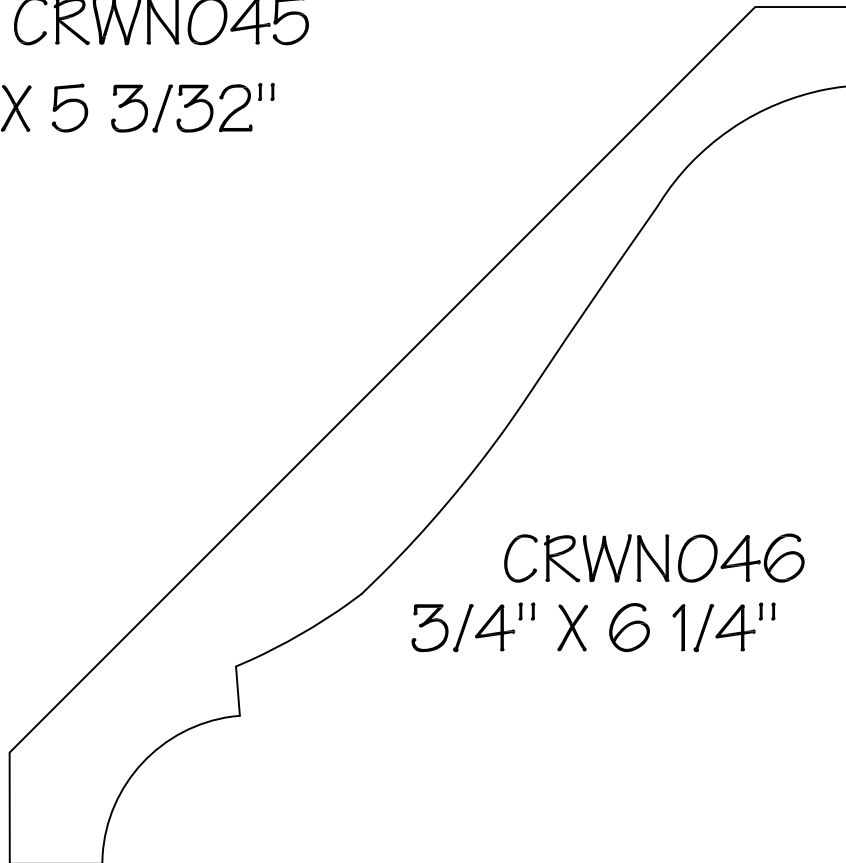

CRWNO46  
3/4" X 6 1/4"

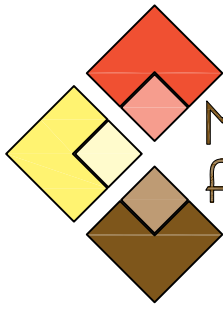

Melbourne  
Architectural  
MILLWORK COMPANY

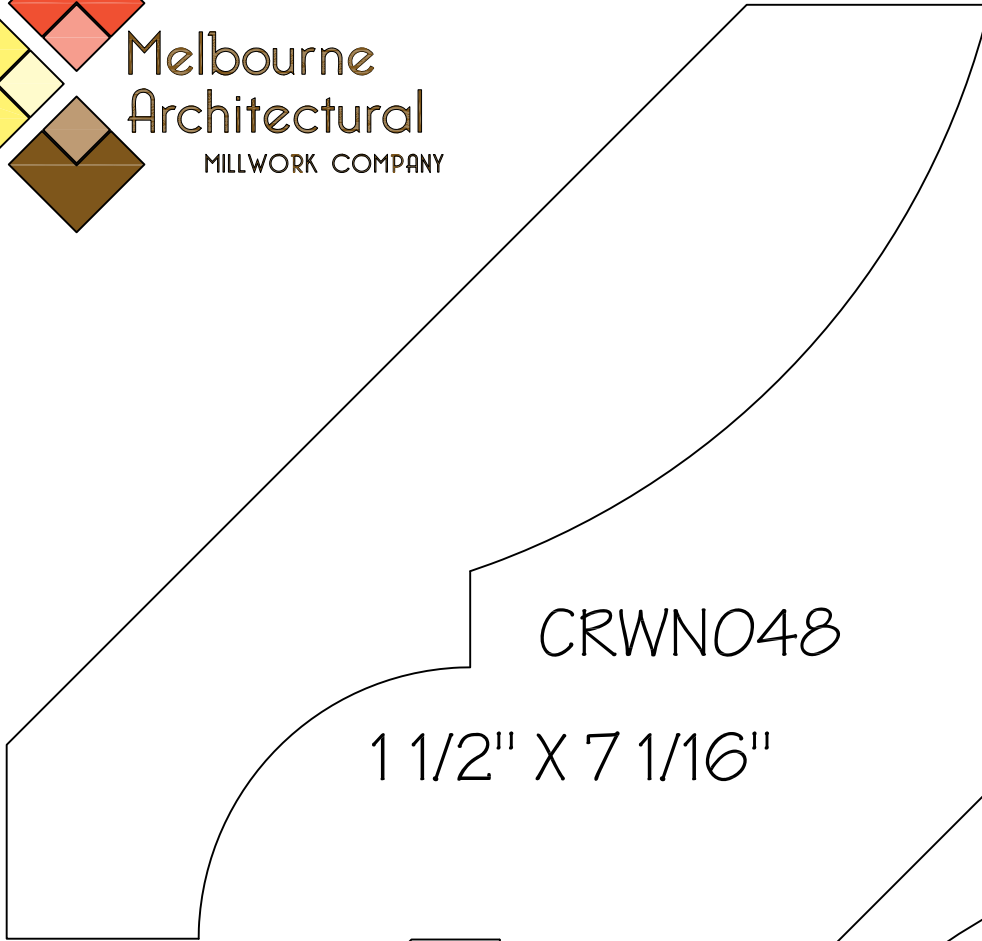

CRWNO48

1 1/2" X 7 1/16"

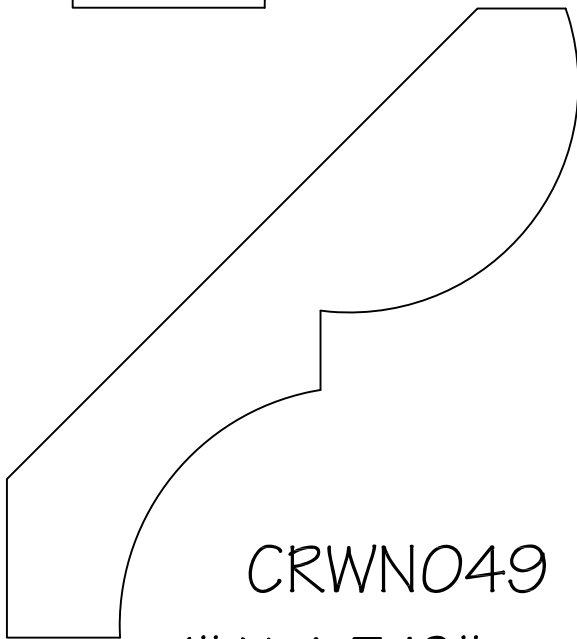

CRWNO49

1" X 4 3/8"

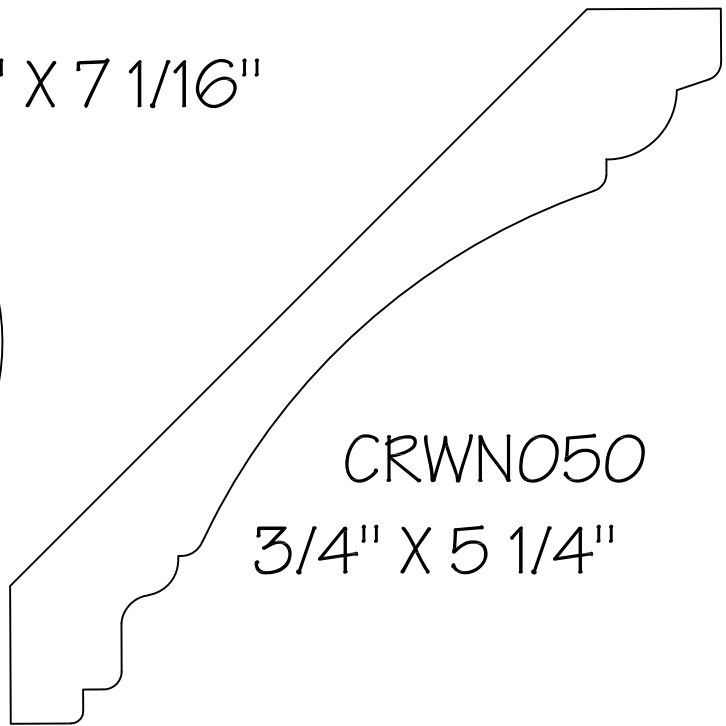

CRWNO50

3/4" X 5 1/4"

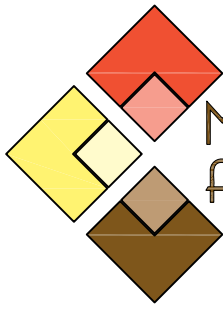

Melbourne  
Architectural  
MILLWORK COMPANY

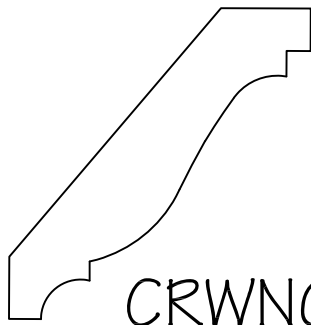

CRWN051

1/2" X 2 1/4"

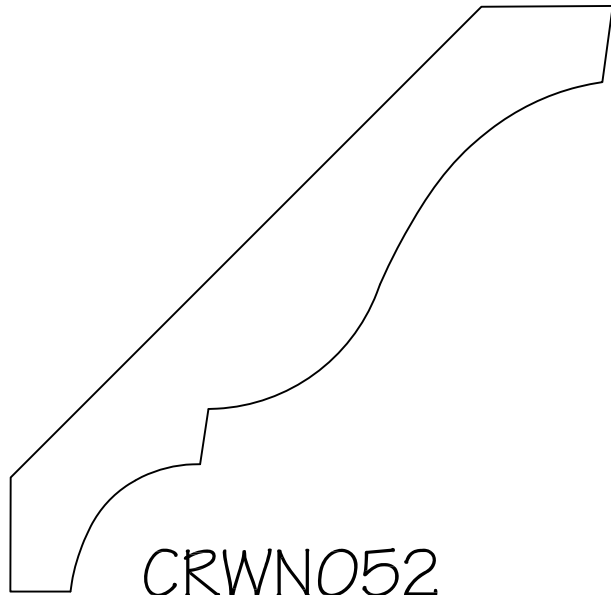

CRWN052

3/4" X 4 3/8"

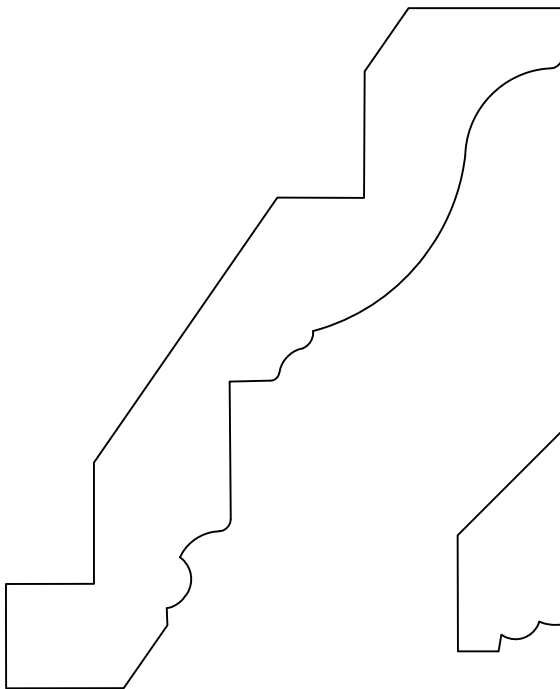

CRWN053

13/16" X 4 9/16"

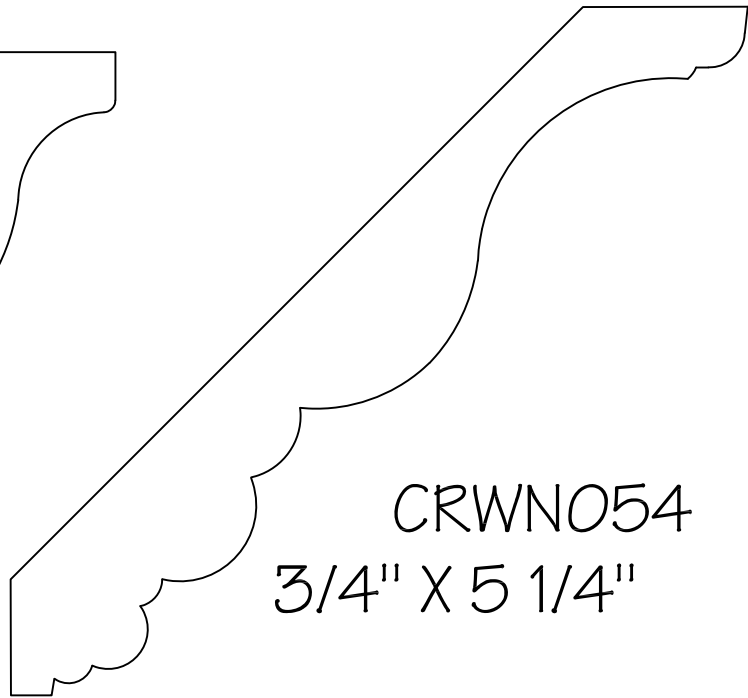

CRWN054

3/4" X 5 1/4"

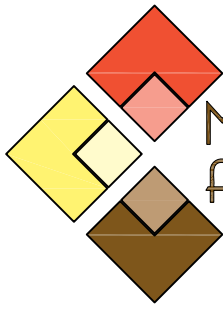

Melbourne  
Architectural  
MILLWORK COMPANY

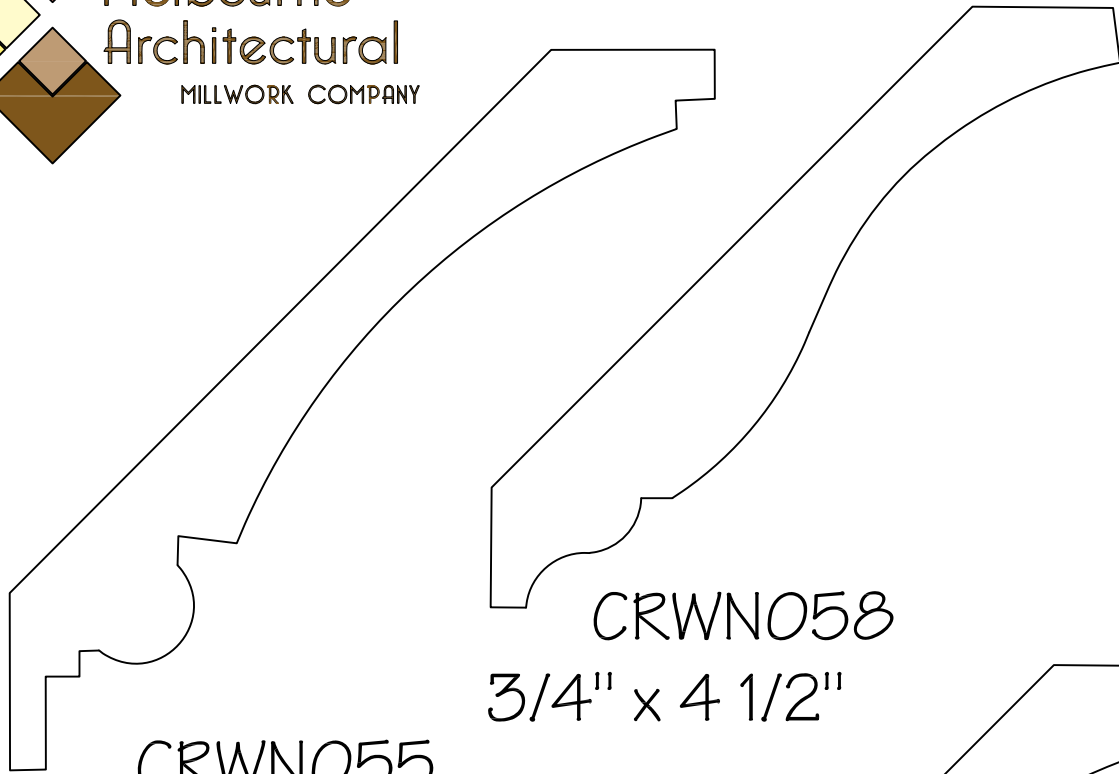

CRWN055  
13/16" X 5 1/4"

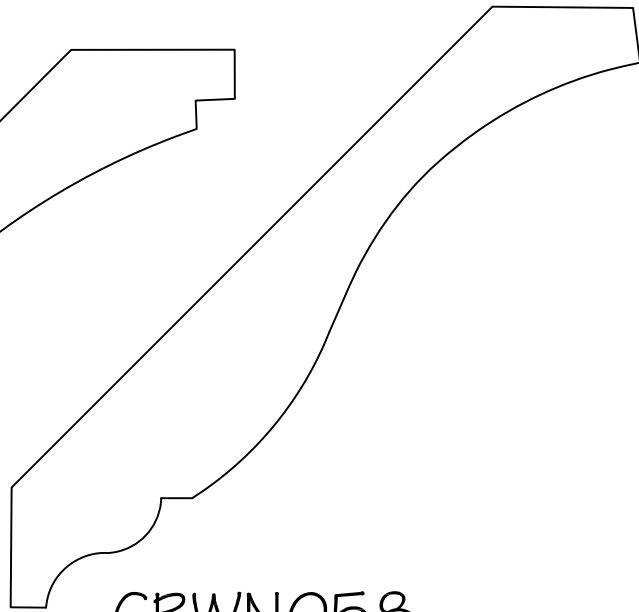

CRWN058  
3/4" x 4 1/2"

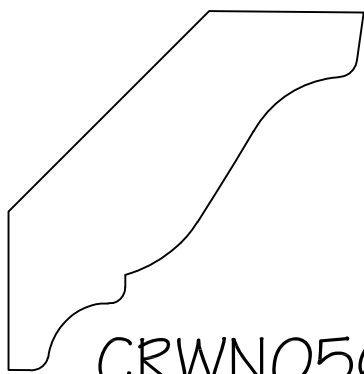

CRWN056  
3/4" X 2 5/8"

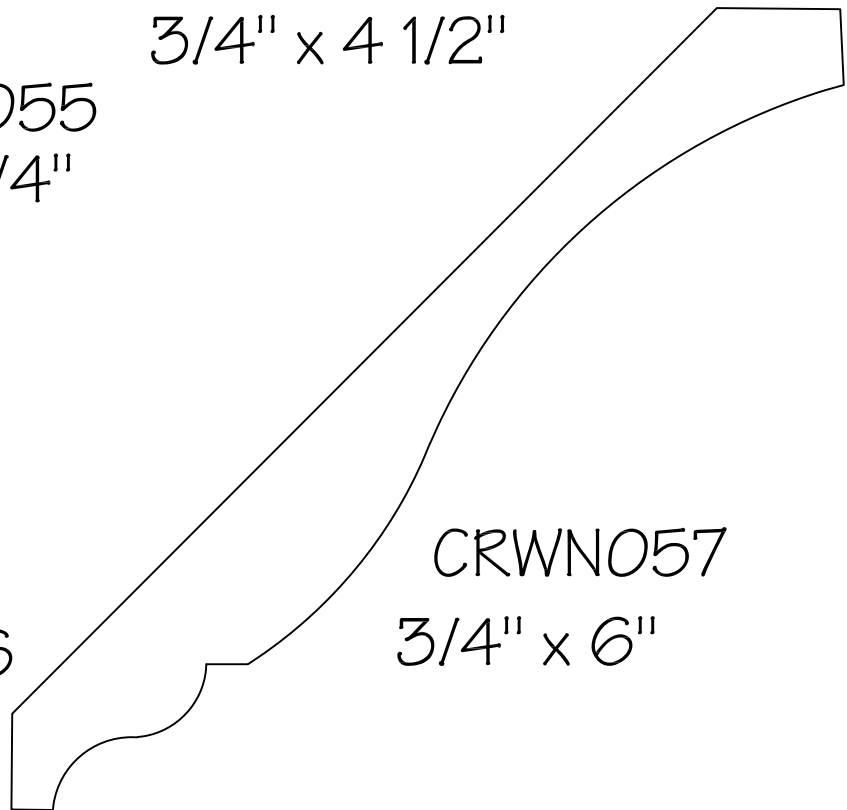

CRWN057  
3/4" x 6"

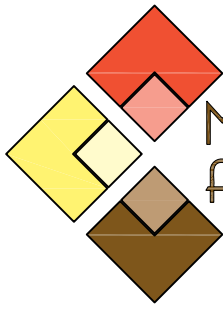

Melbourne  
Architectural  
MILLWORK COMPANY



CRWN060

13/16" x 7 5/8"

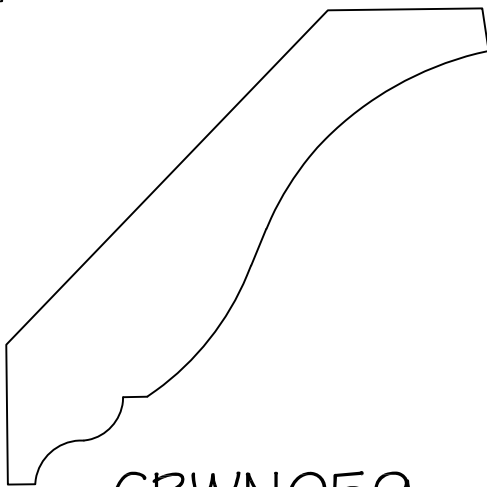

CRWN059

3/4" x 3 1/2"

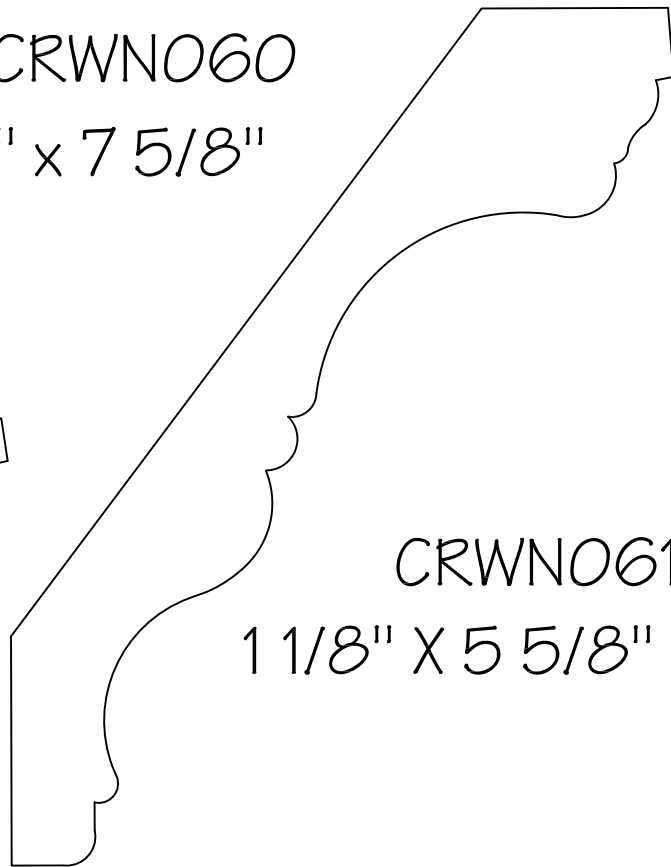

CRWN061

1 1/8" x 5 5/8"



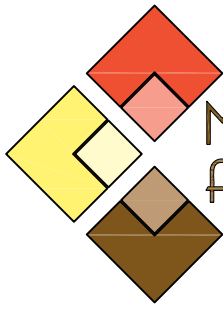

Melbourne  
Architectural  
MILLWORK COMPANY

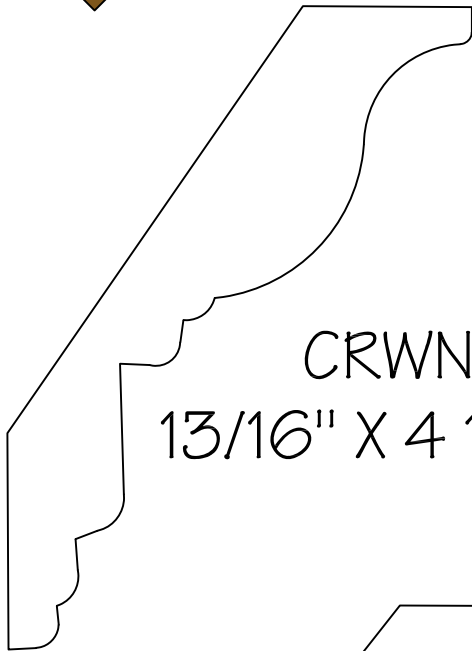

CRWN062  
13/16" X 4 1/8"

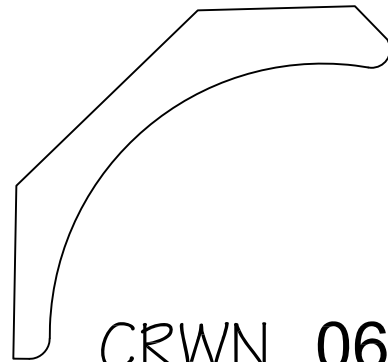

CRWN 063  
7/8" x 2 9/16"

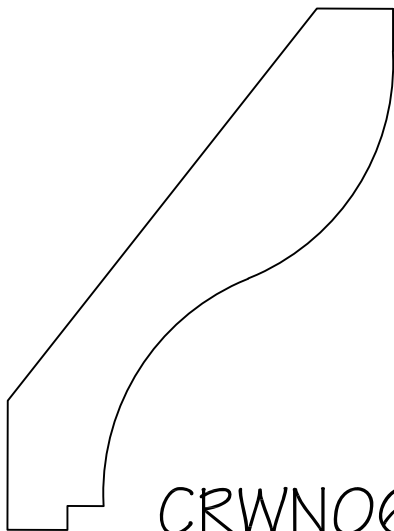

CRWN064  
3/4" x 3 3/8"

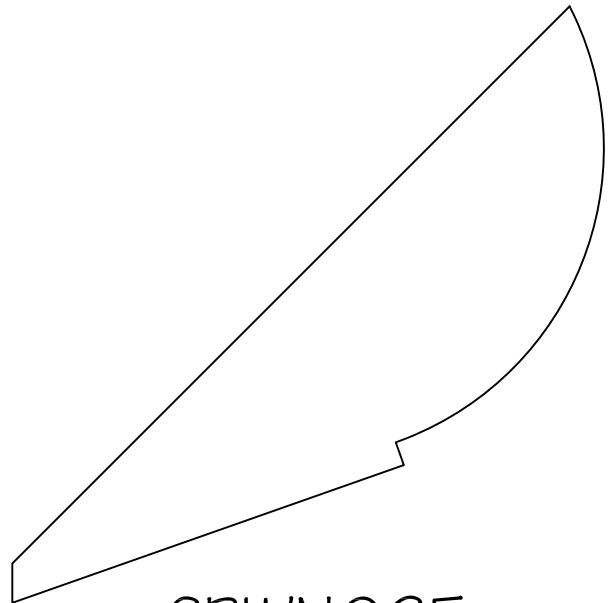

CRWN065  
1 1/8" x 4 1/4"

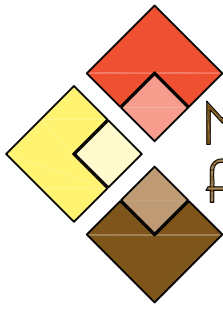

Melbourne  
Architectural  
MILLWORK COMPANY

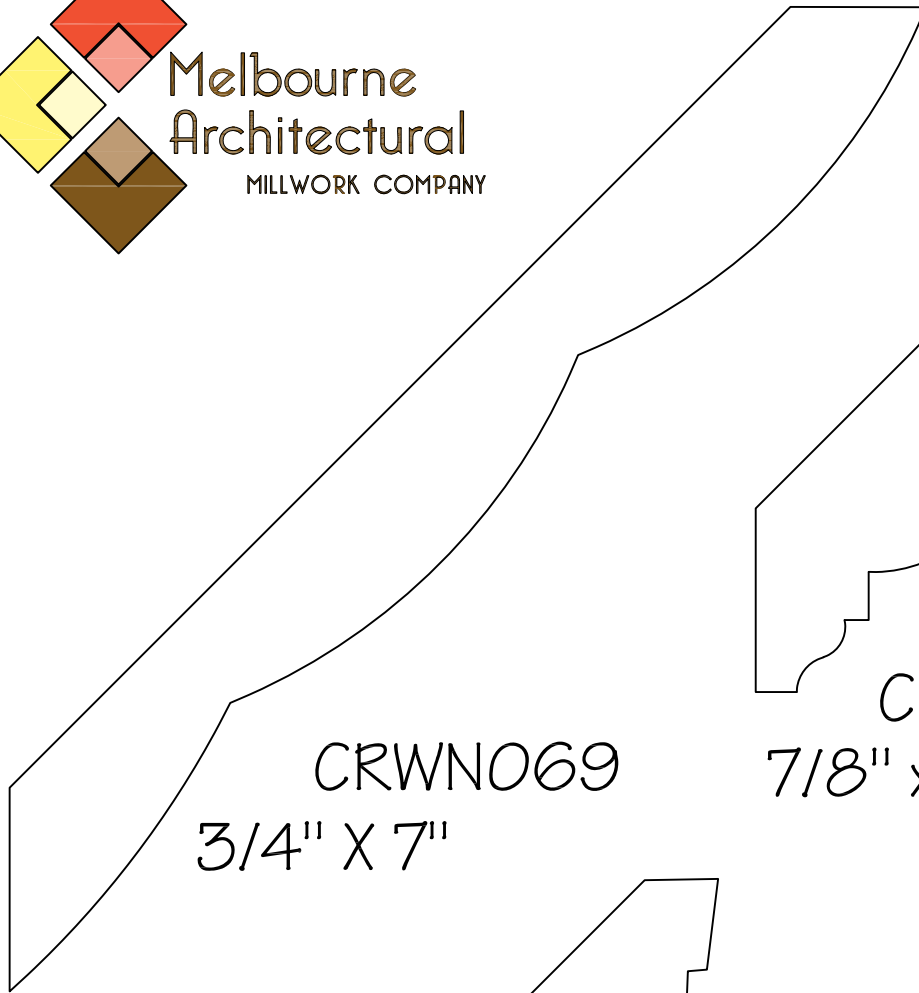

CRWN069  
3/4" X 7"

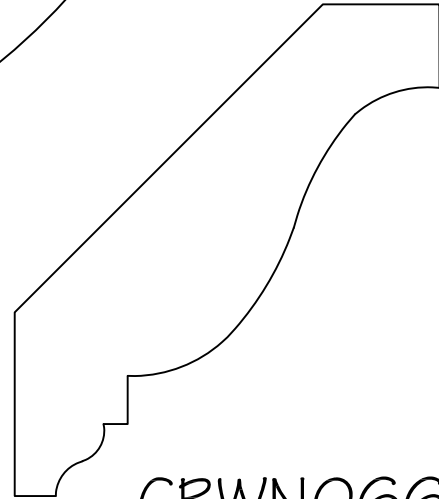

CRWN066  
7/8" X 3 3/8"

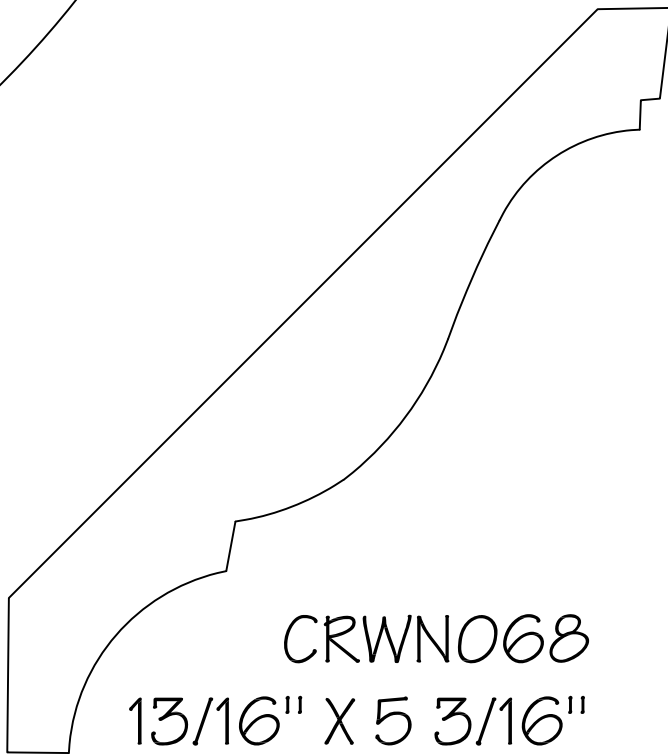

CRWN068  
13/16" X 5 3/16"

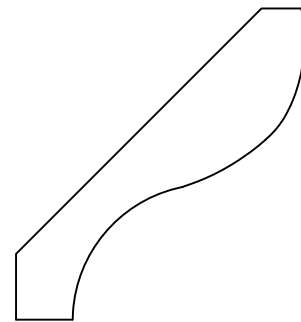

CRWN067  
1/2" X 2 3/16"

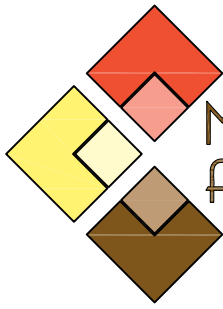

Melbourne  
Architectural  
MILLWORK COMPANY

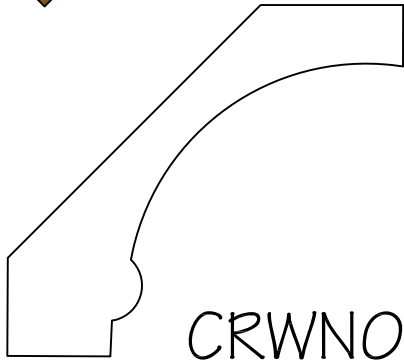

CRWN070

$3/4'' \times 2 \ 3/4''$

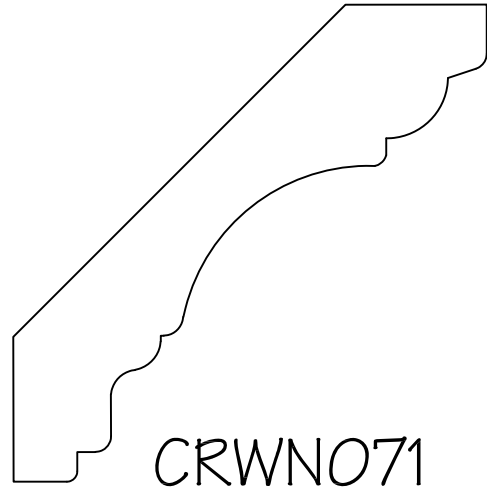

CRWN071

$3/4'' \times 3 \ 1/2''$

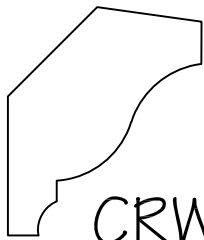

CRWN072

$5/8'' \times 1 \ 1/2''$

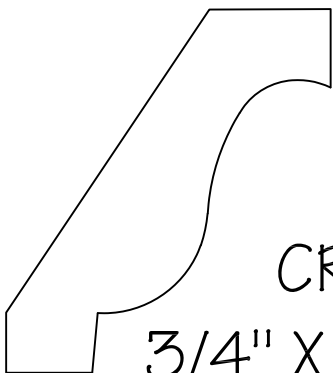

CRWN073

$3/4'' \times 2 \ 9/16''$

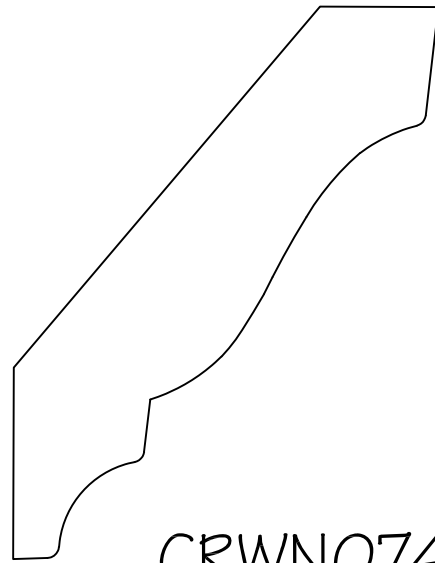

CRWN074

$13/16'' \times 3 \ 5/8''$

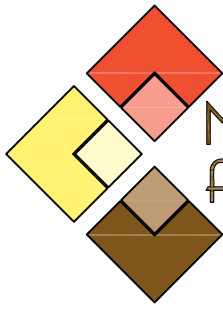

Melbourne  
Architectural  
MILLWORK COMPANY

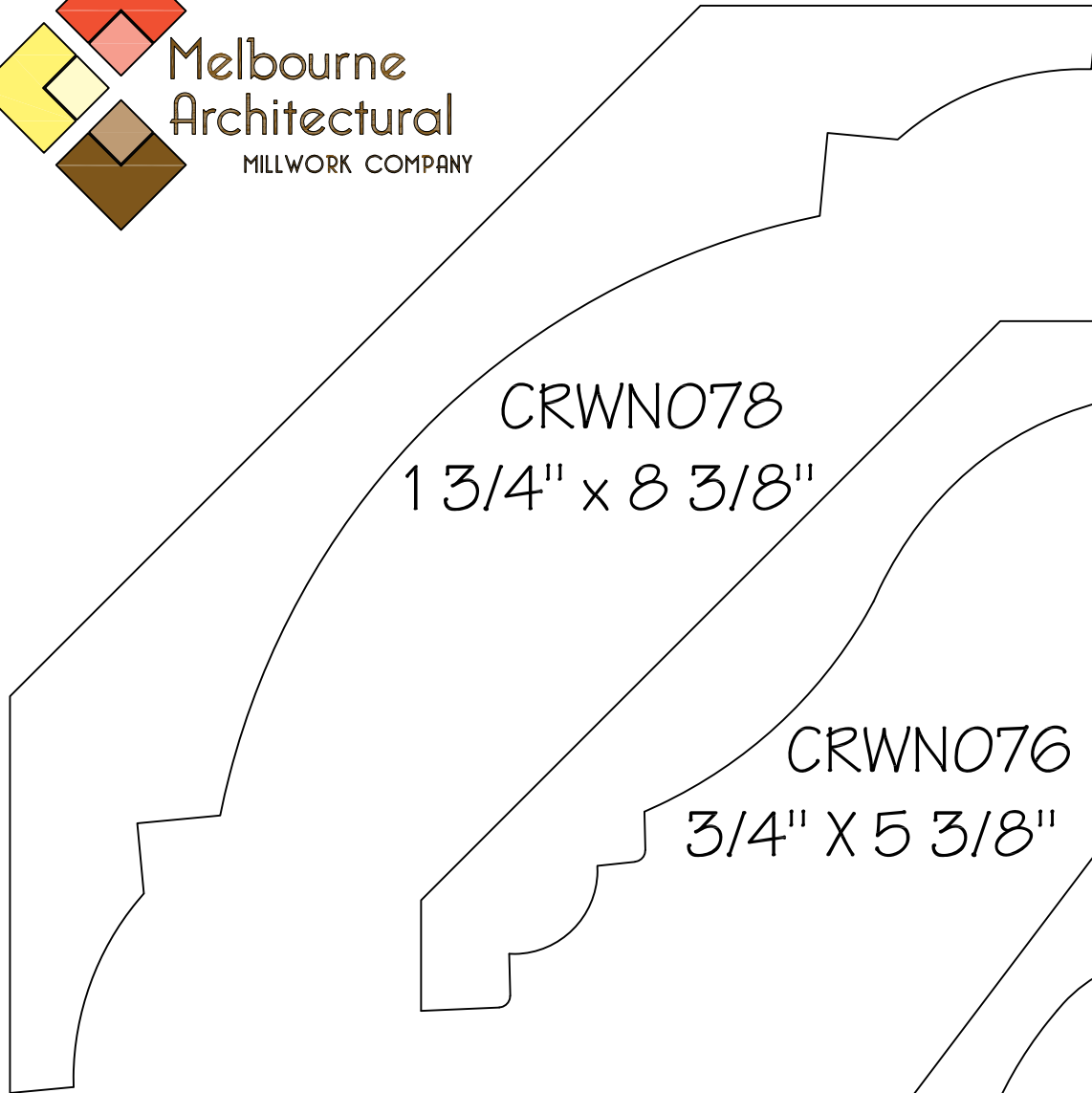

CRWN078  
1 3/4" x 8 3/8"

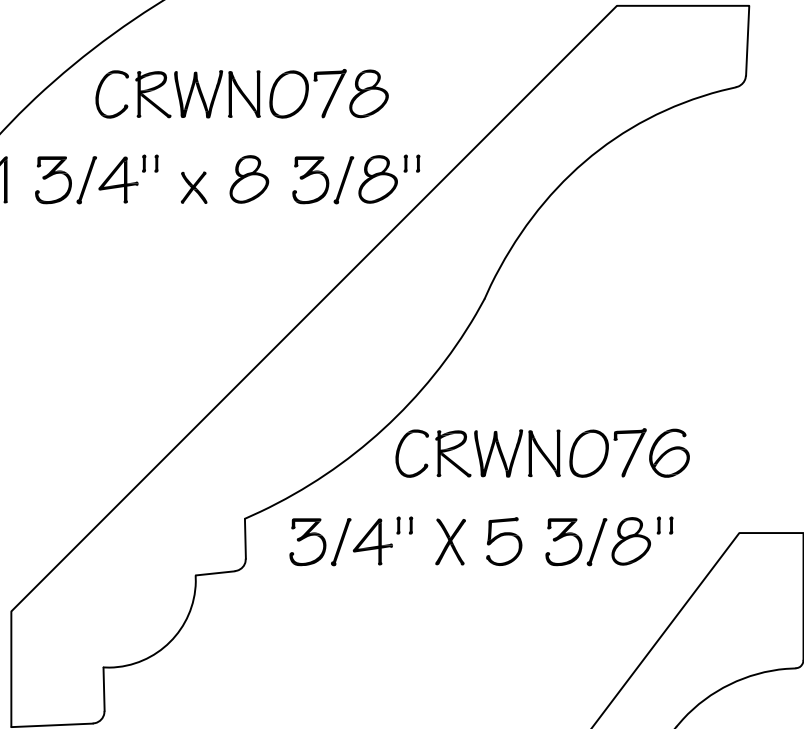

CRWN076  
3/4" x 5 3/8"

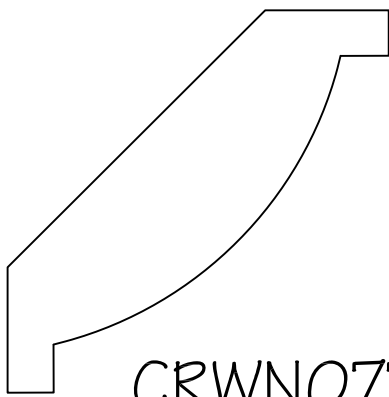

CRWN077  
3/4" x 2 13/16"

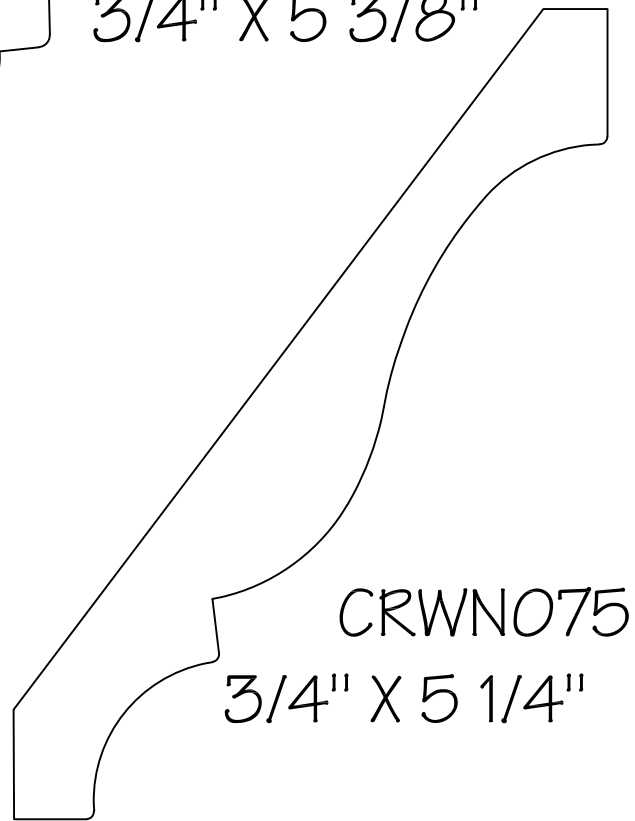

CRWN075  
3/4" x 5 1/4"

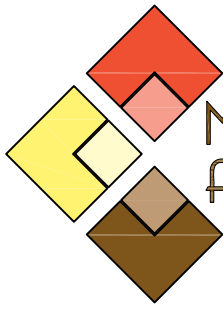

Melbourne  
Architectural  
MILLWORK COMPANY

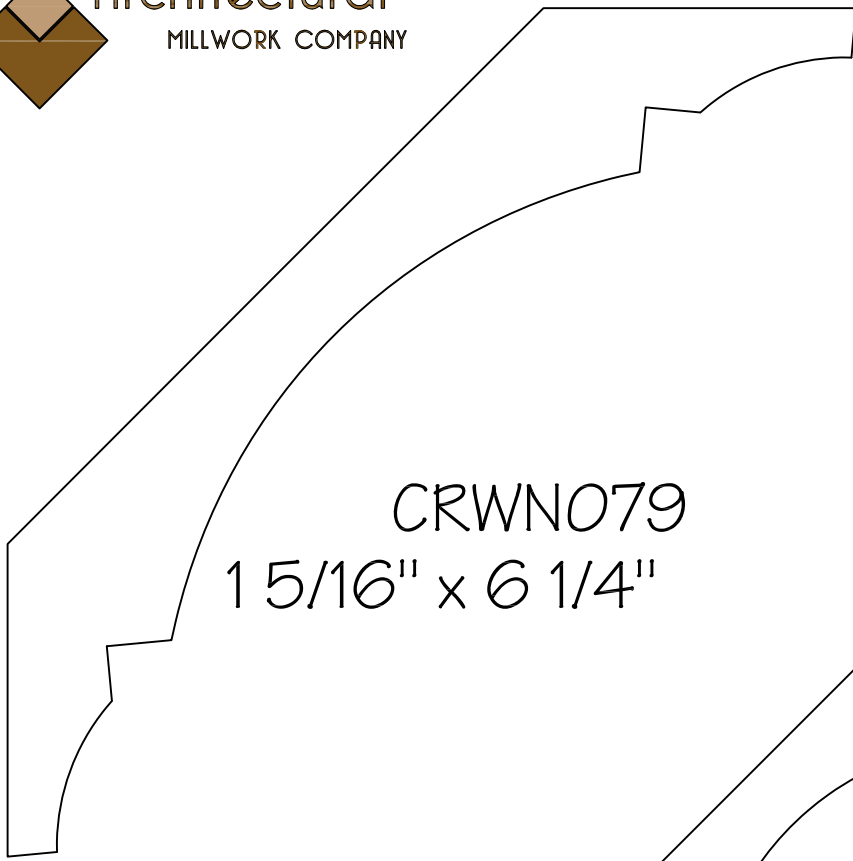

CRWNO79  
1 5/16" x 6 1/4"

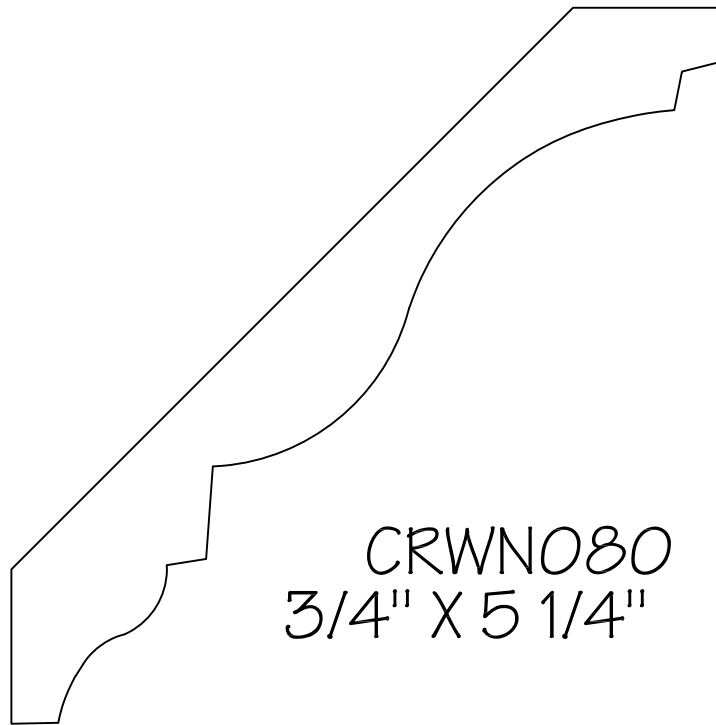

CRWNO80  
3/4" x 5 1/4"

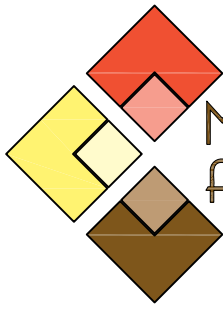

Melbourne  
Architectural  
MILLWORK COMPANY

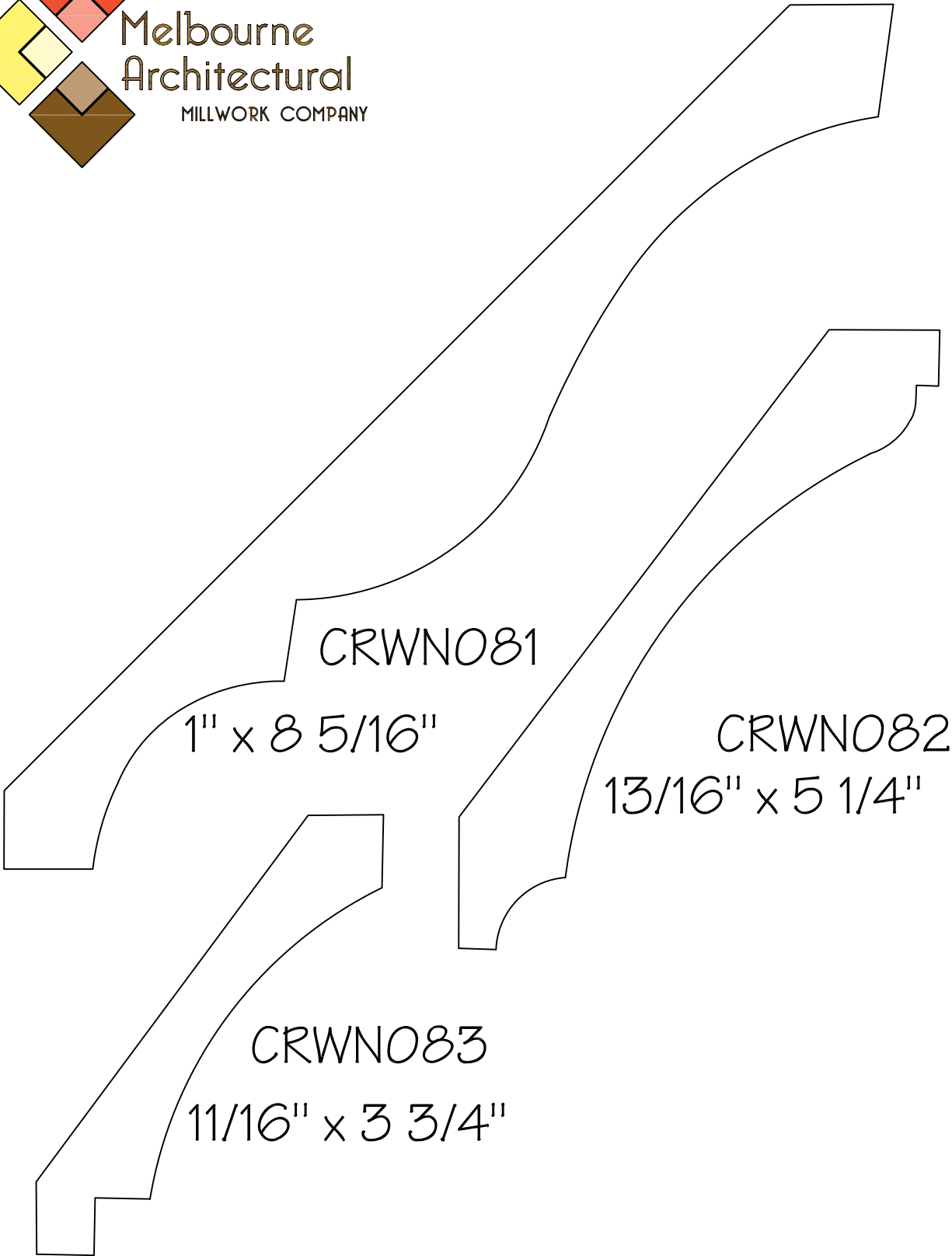

C24

325 East Drive - Melbourne, FL 32904  
321-308-3297 - Fax 321-308-3299

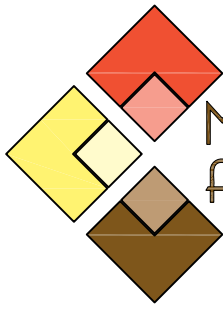

Melbourne  
Architectural  
MILLWORK COMPANY

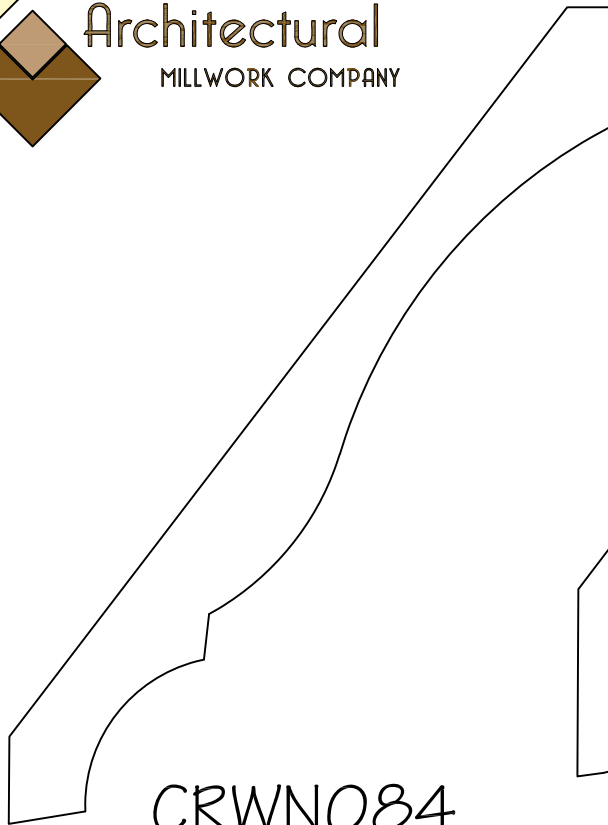

CRWN084  
9/16" x 5 5/16"

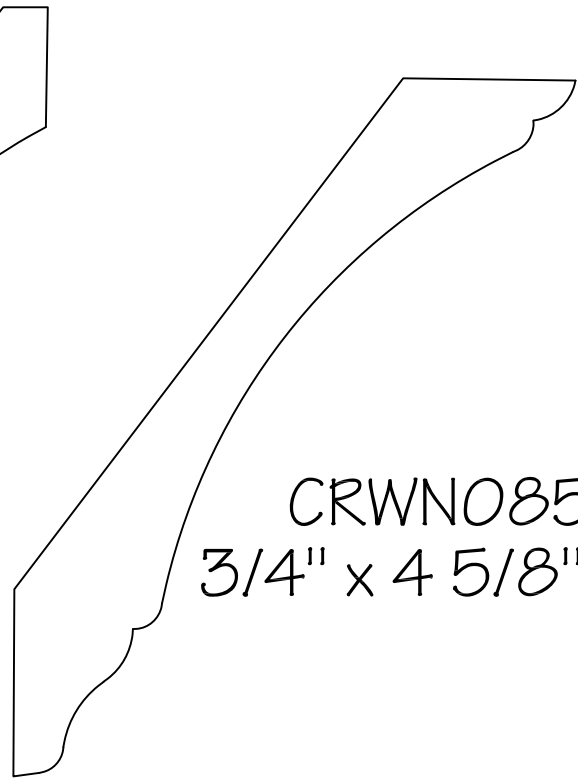

CRWN085  
3/4" x 4 5/8"

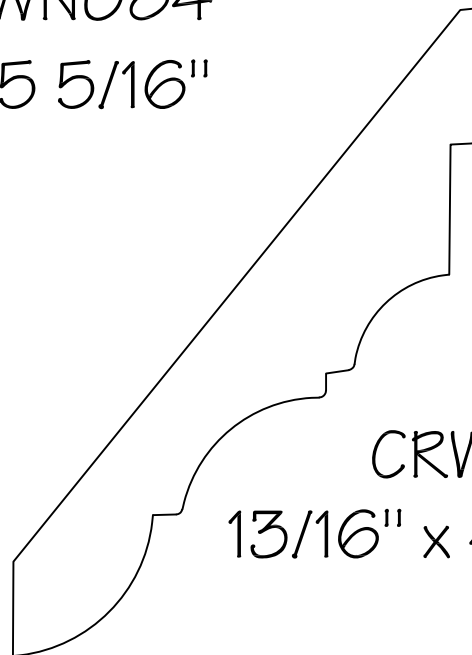

CRWN087  
13/16" x 4 3/16"

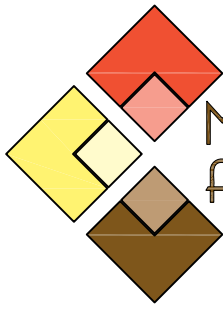

Melbourne  
Architectural  
MILLWORK COMPANY

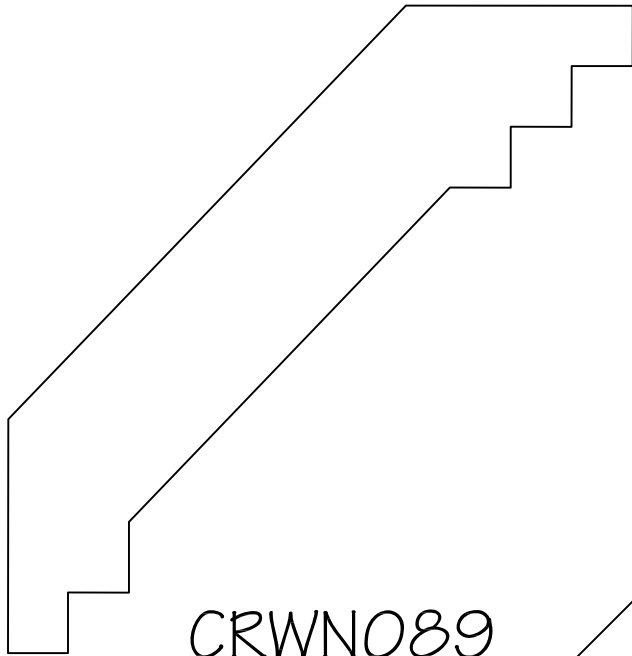

CRWN089  
1 1/16" x 4 11/16"

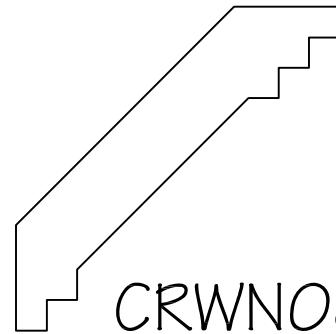

CRWN088  
1/2" x 2 3/8"

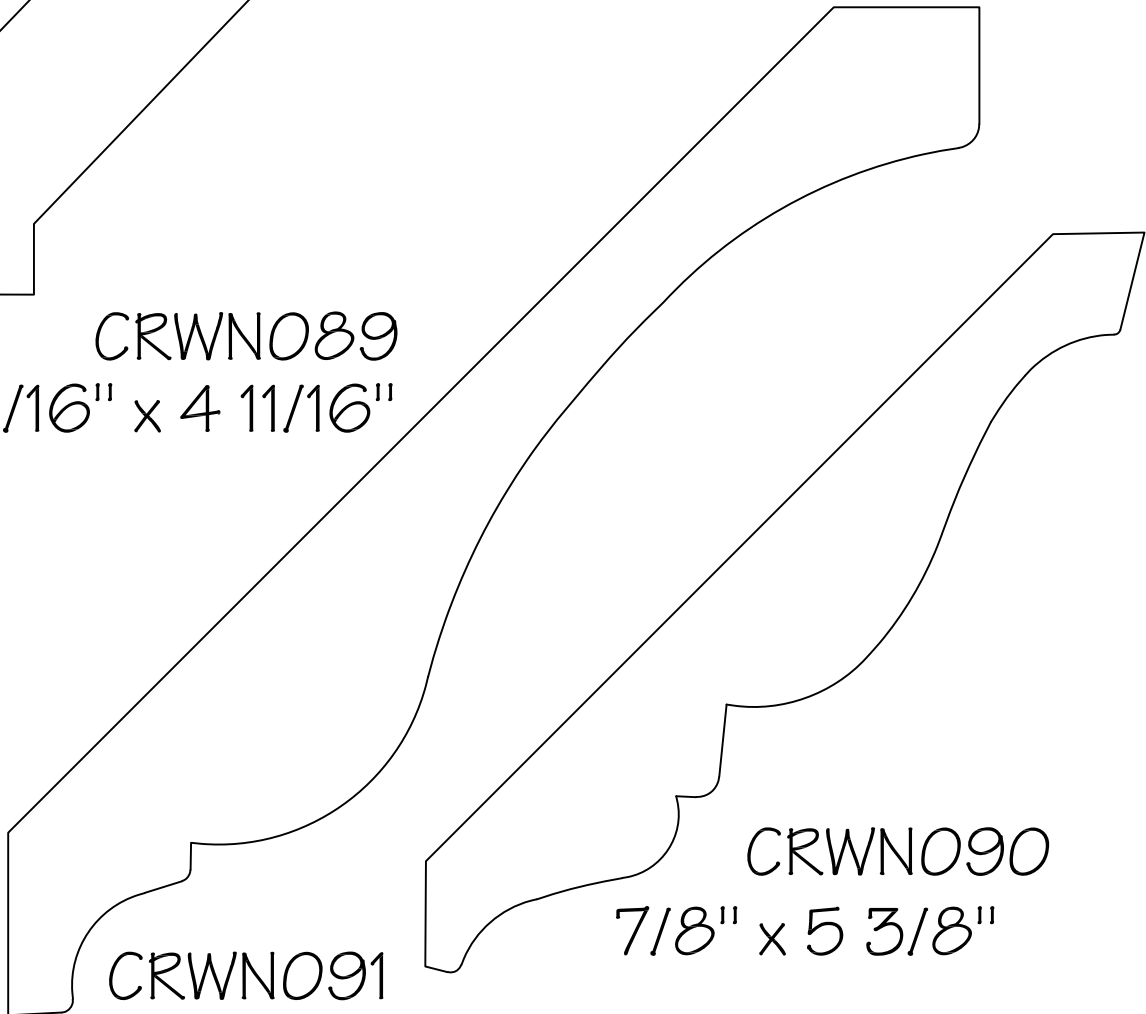

CRWN090  
7/8" x 5 3/8"

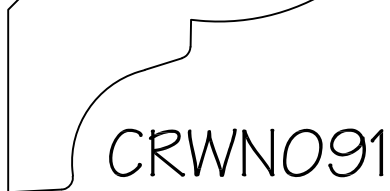

CRWN091  
1 1/8" x 7 5/16"



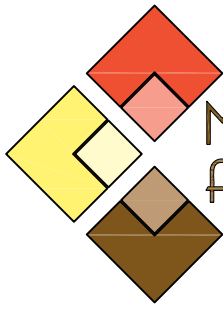

Melbourne  
Architectural  
MILLWORK COMPANY

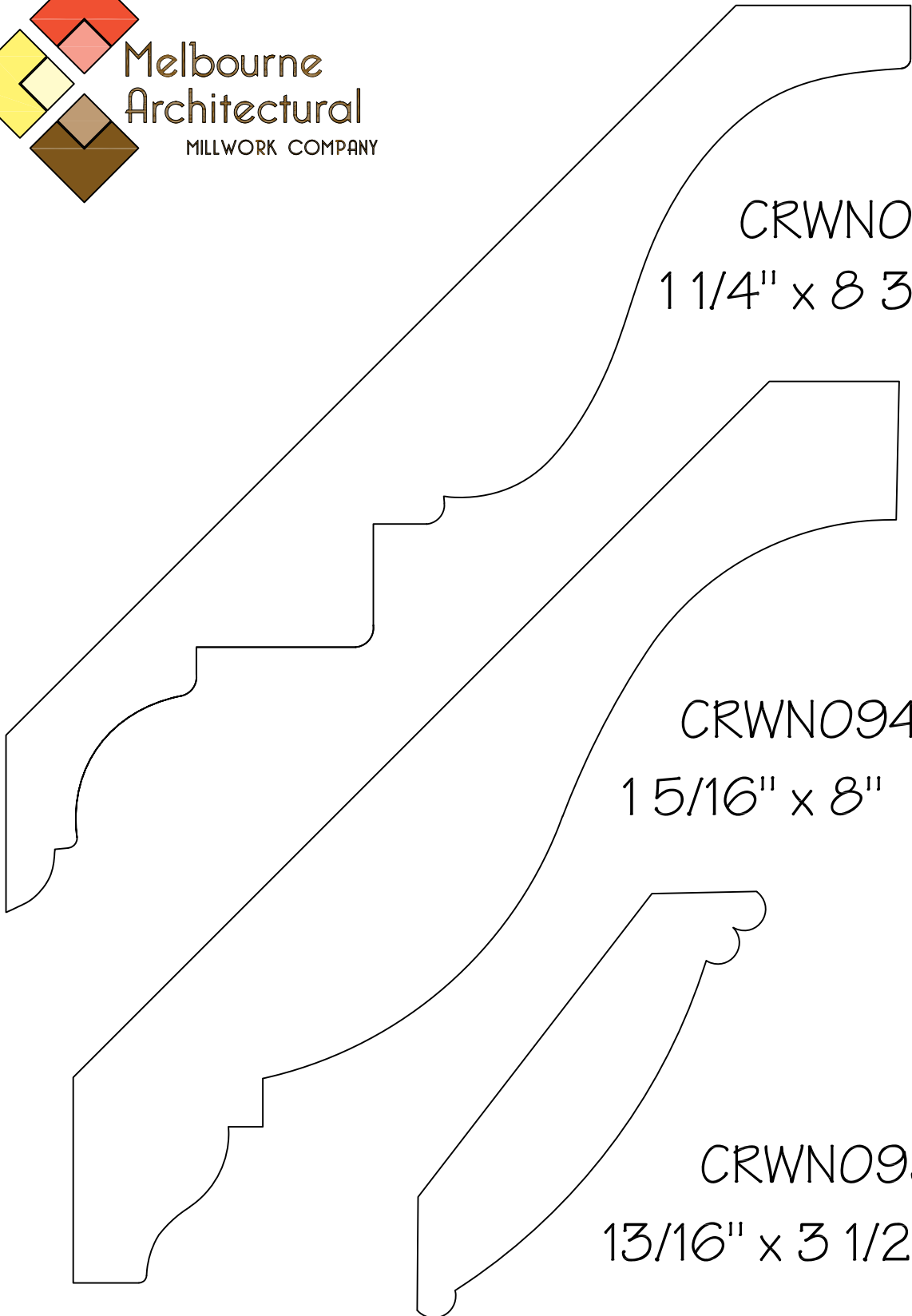

CRWN092  
1 1/4" x 8 3/8"

CRWN094  
1 5/16" x 8"

CRWN093  
13/16" x 3 1/2"

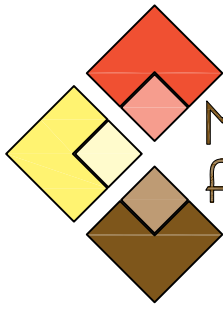

Melbourne  
Architectural  
MILLWORK COMPANY

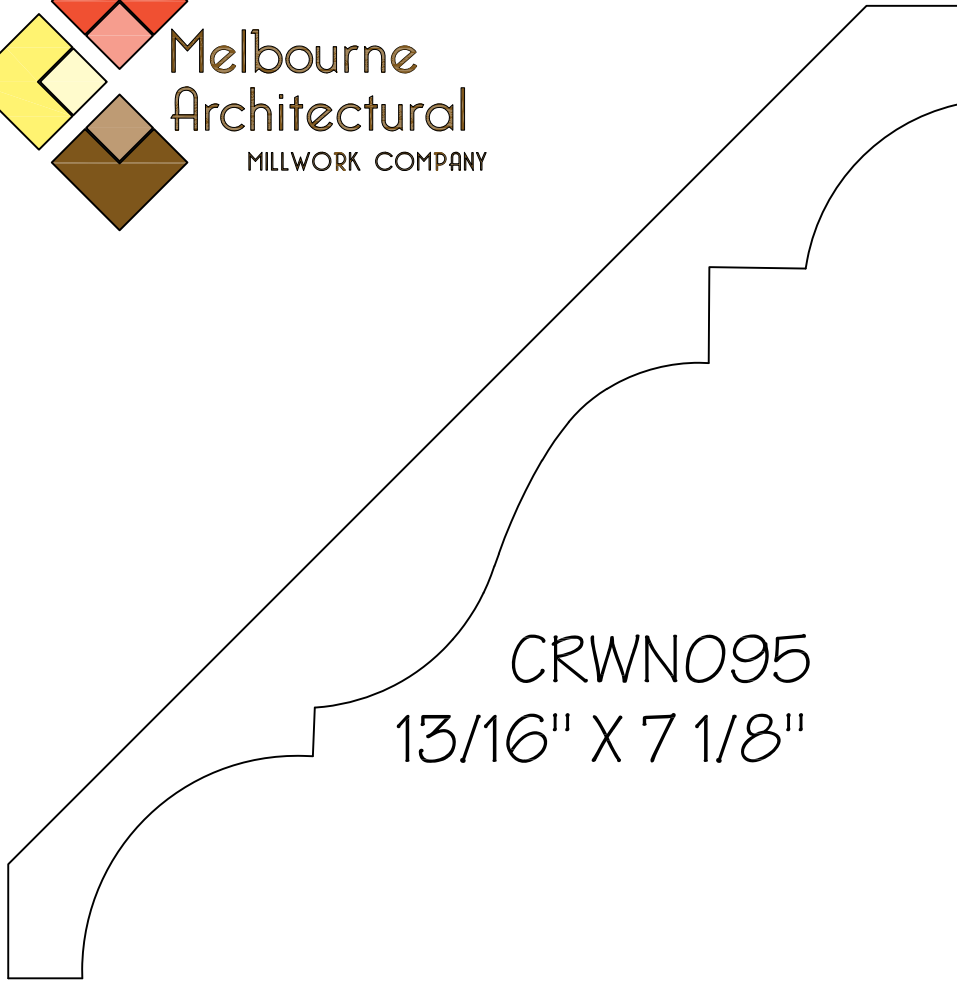

CRWN095  
13/16" X 7 1/8"

RESERVED FOR  
CRWN096

C28

325 East Drive - Melbourne, FL 32904  
321-308-3297 - Fax 321-308-3299



RESERVED FOR  
CRWN097

RESERVED FOR  
CRWN098

RESERVED FOR  
CRWN099

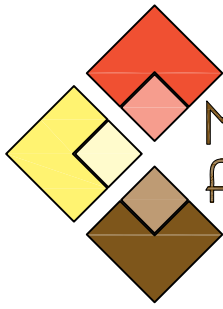

Melbourne  
Architectural  
MILLWORK COMPANY

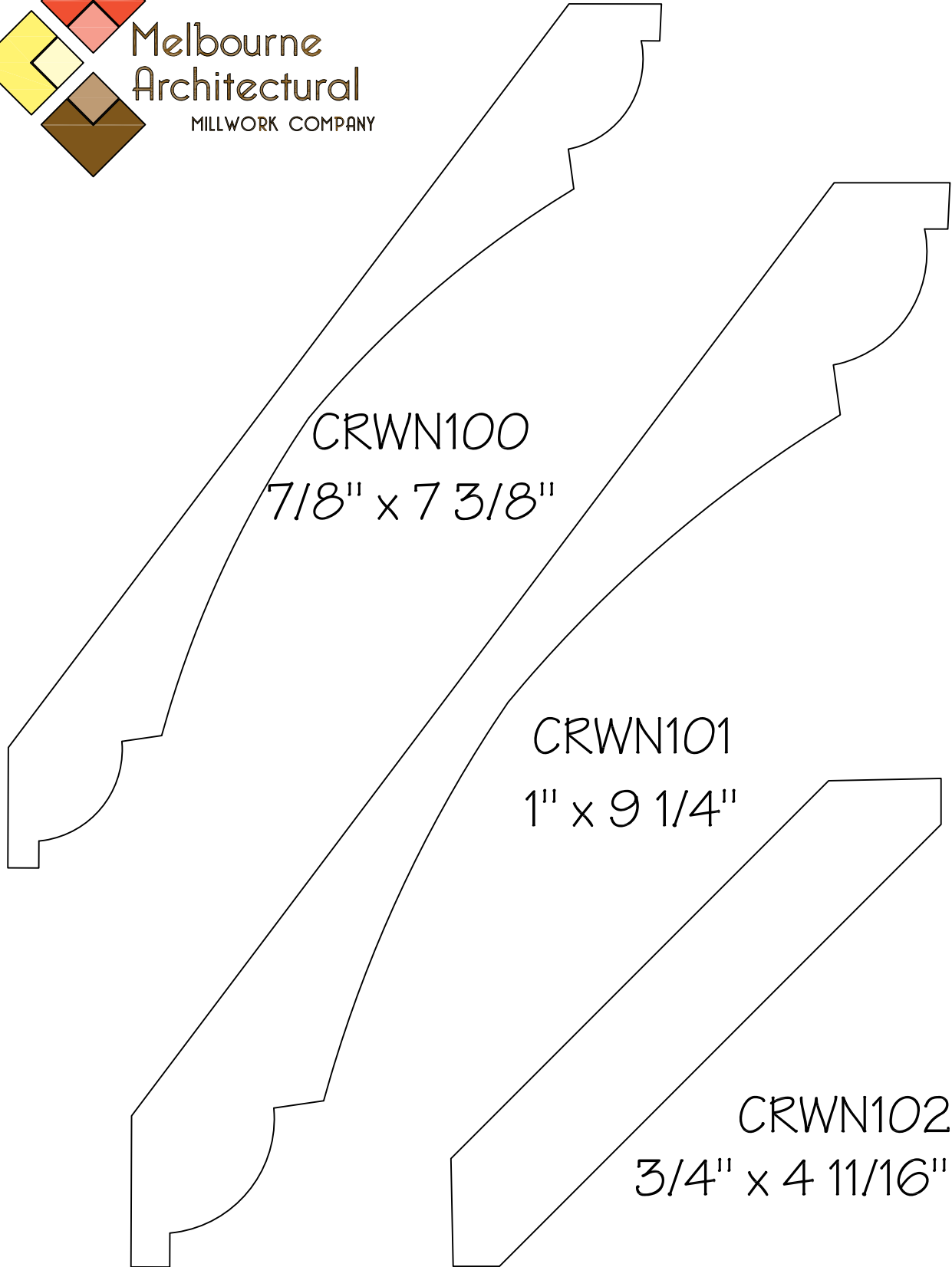

C30

325 East Drive - Melbourne, FL 32904  
321-308-3297 - Fax 321-308-3299

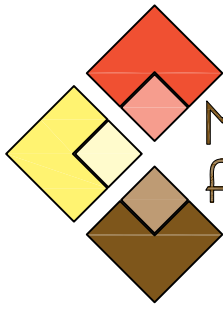

Melbourne  
Architectural  
MILLWORK COMPANY

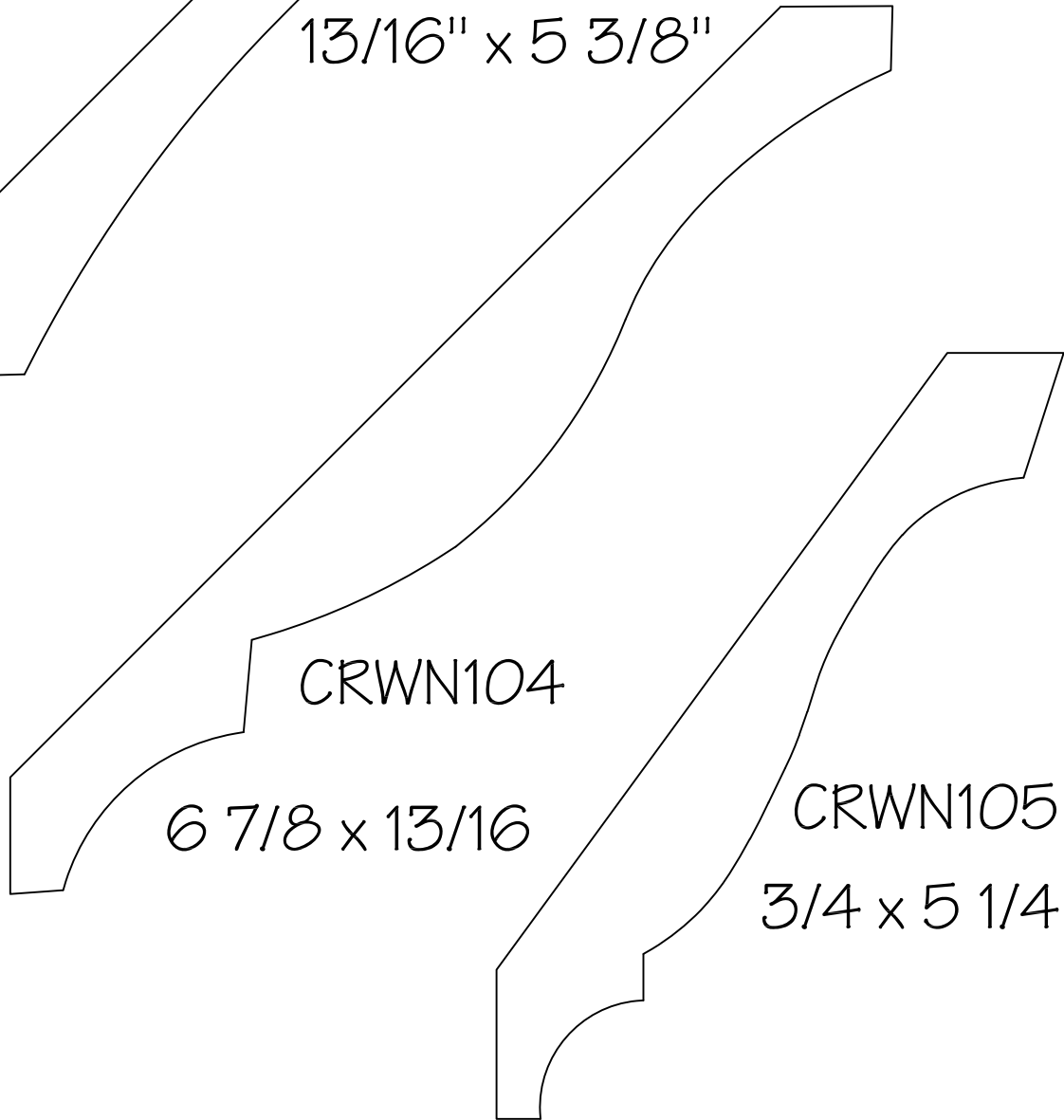
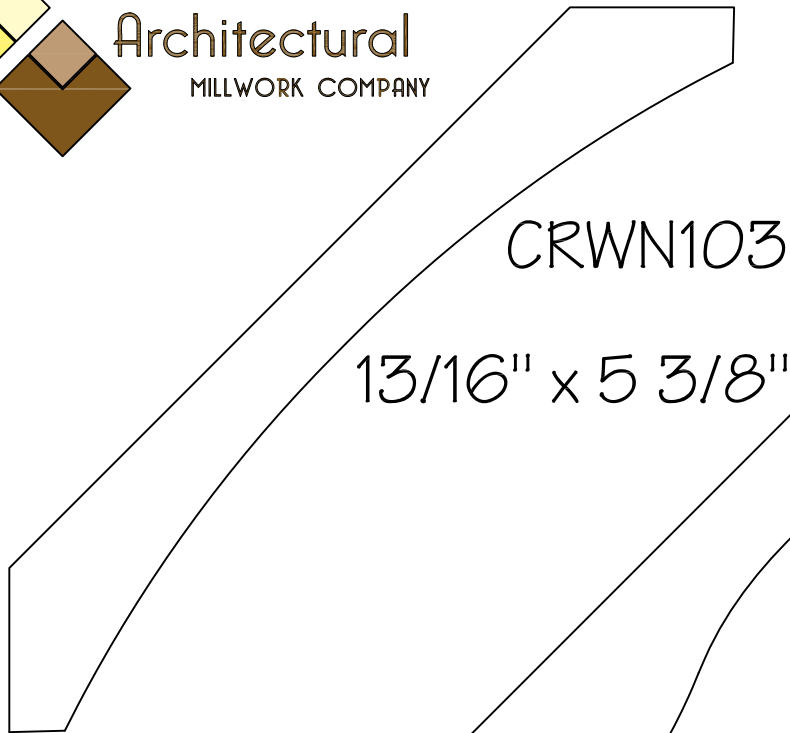

CRWN105  
 $3/4 \times 5 \frac{1}{4}$

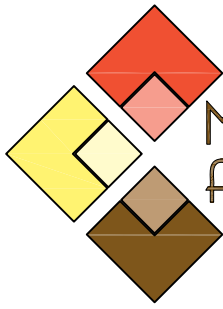

Melbourne  
Architectural  
MILLWORK COMPANY



CRWN106  
1 1/16" x 8 1/8"

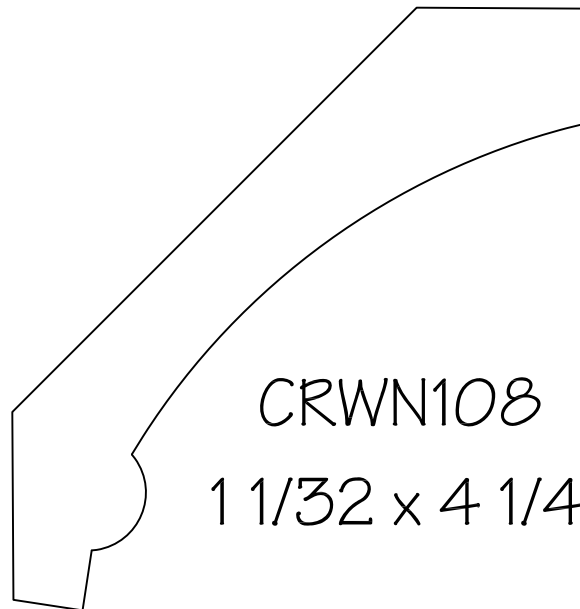

CRWN108  
1 1/32" x 4 1/4"

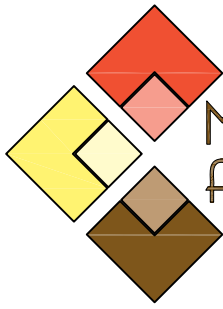

Melbourne  
Architectural  
MILLWORK COMPANY



CRWN109  
1 1/16 x 6 7/16

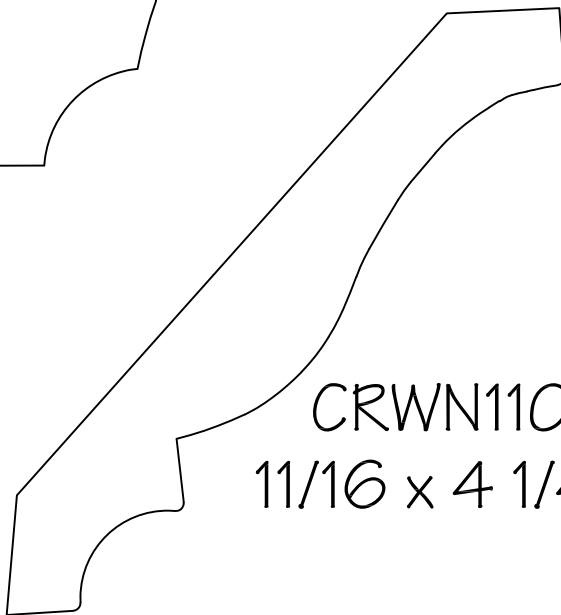

CRWN110  
11/16 x 4 1/4

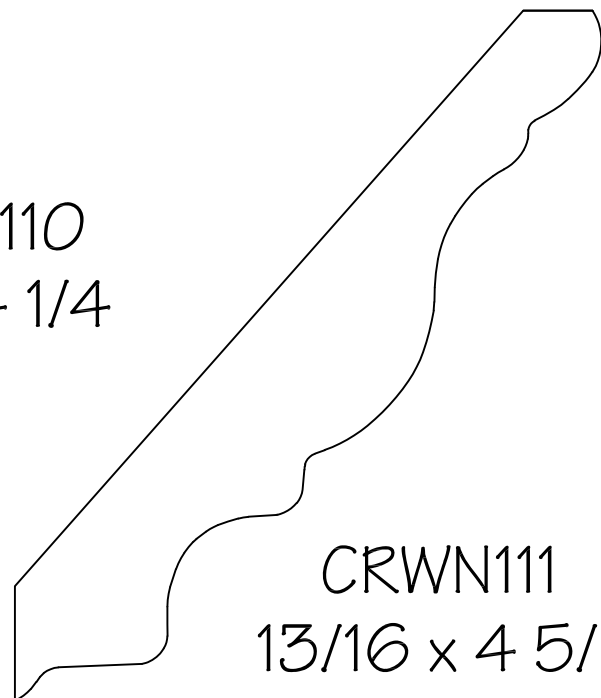

CRWN111  
13/16 x 4 5/8

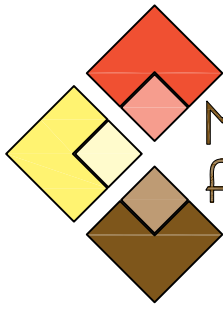

Melbourne  
Architectural  
MILLWORK COMPANY

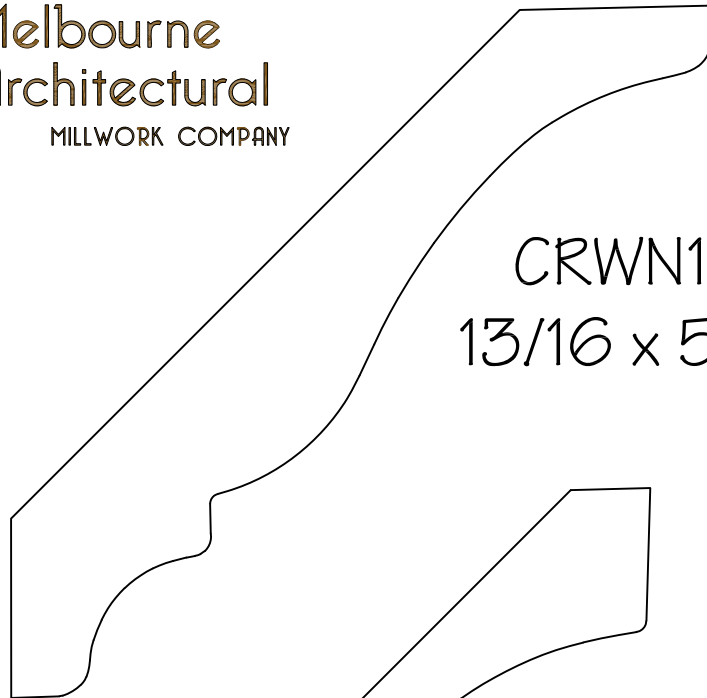

CRWN112  
13/16 x 5 1/8

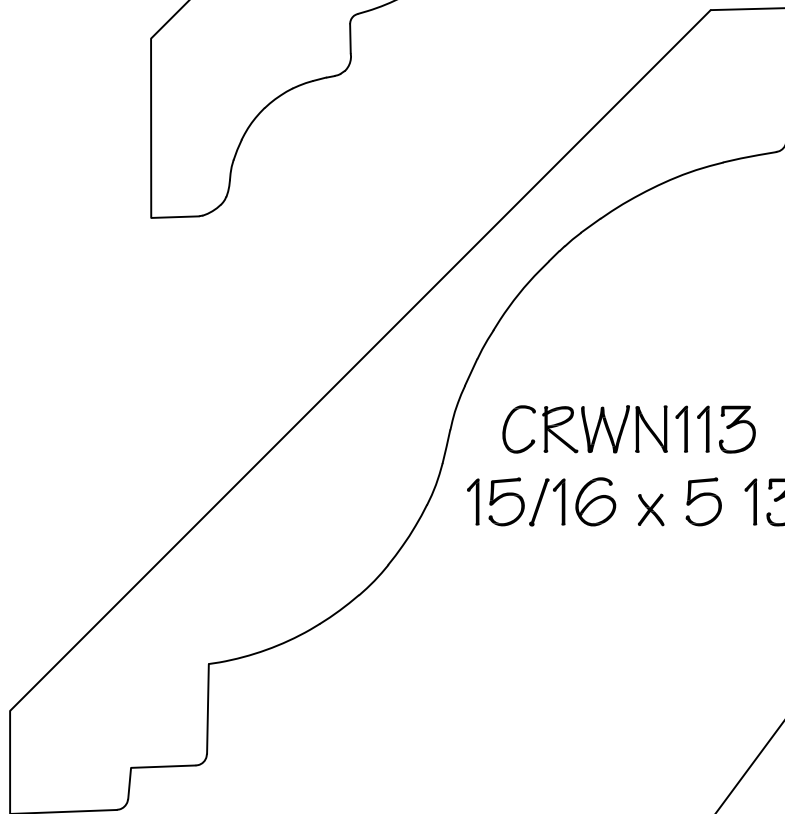

CRWN113  
15/16 x 5 13/16

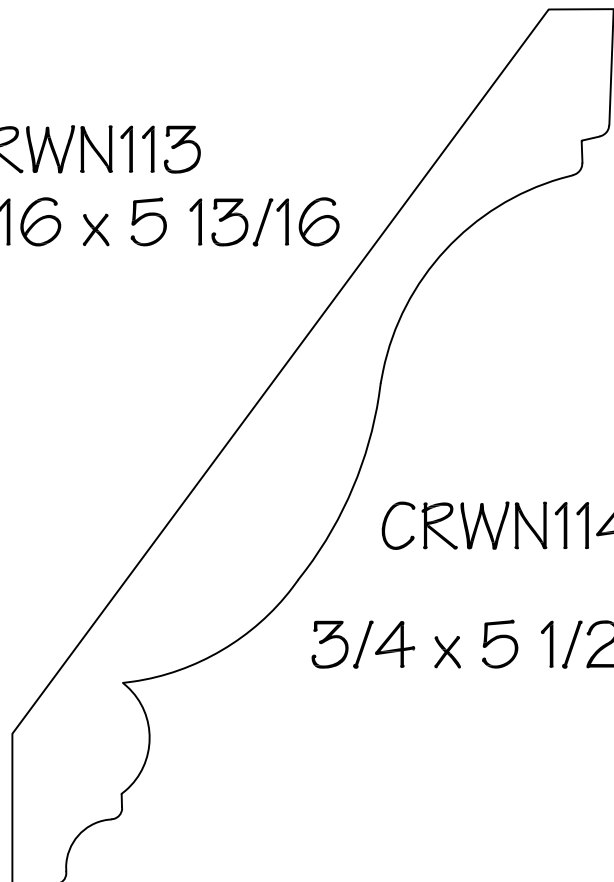

CRWN114  
3/4 x 5 1/2



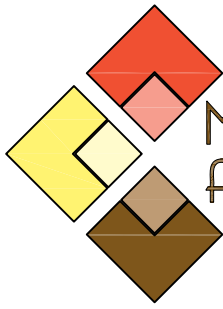

Melbourne  
Architectural  
MILLWORK COMPANY

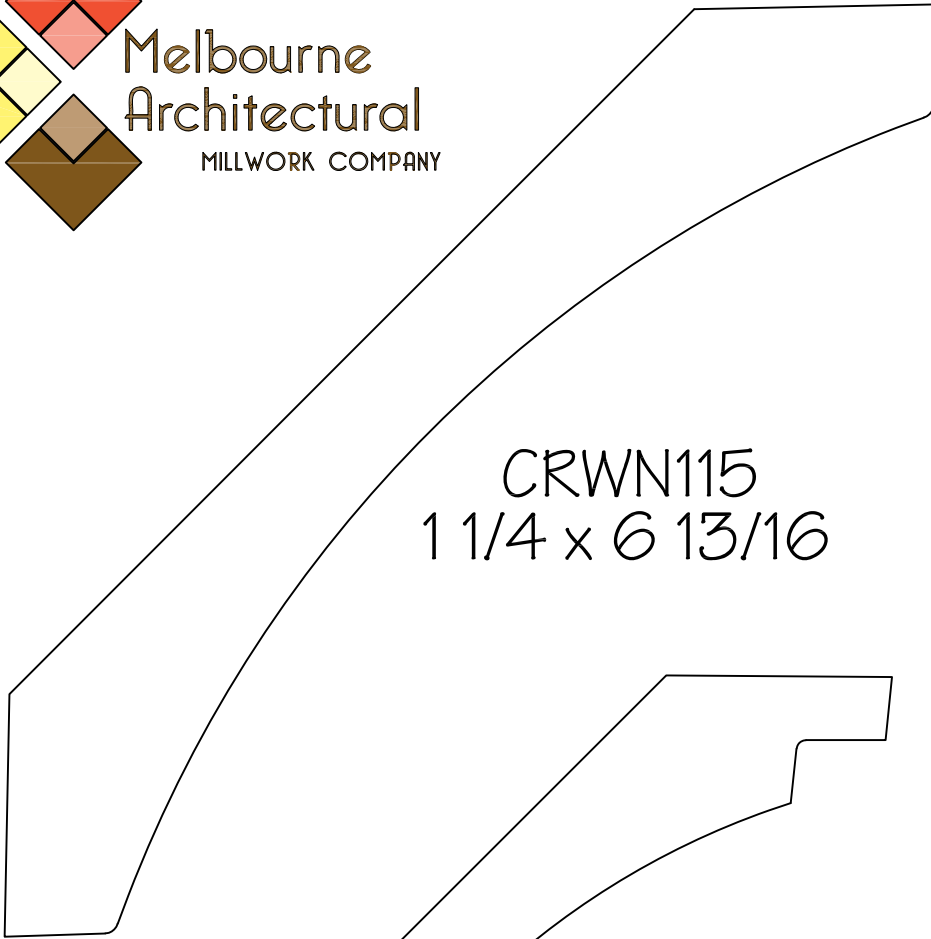

CRWN115  
1 1/4 x 6 13/16

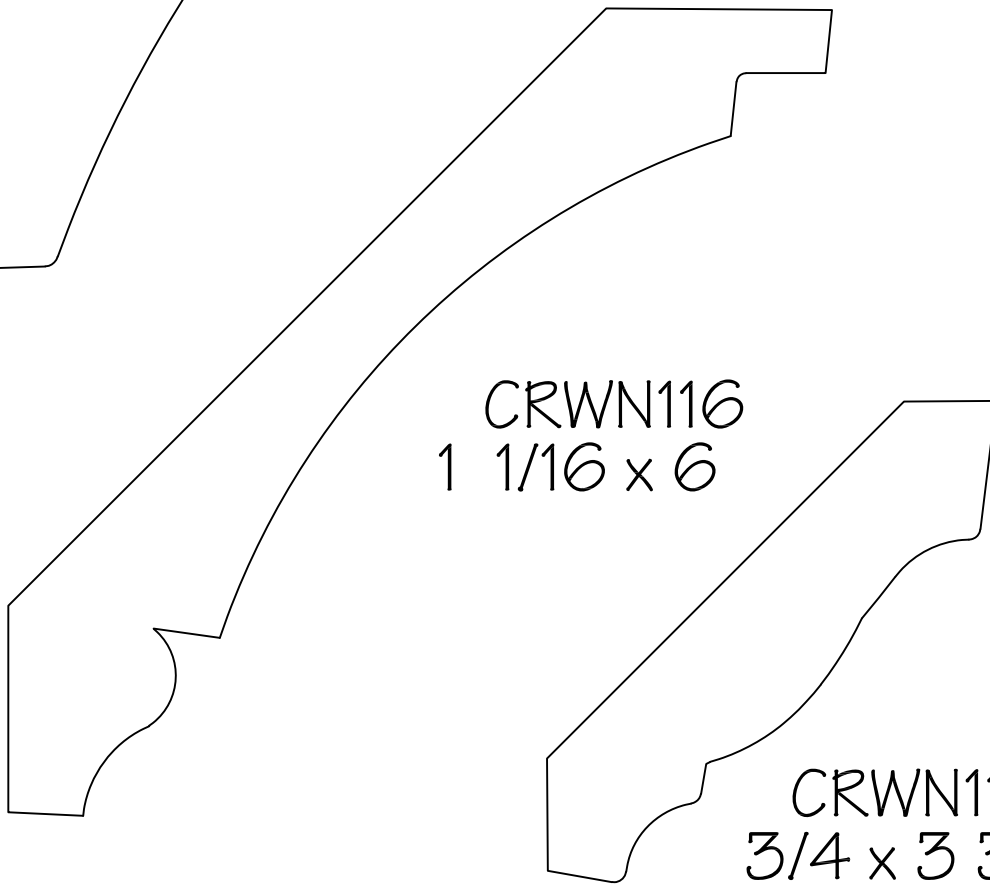

CRWN116  
1 1/16 x 6

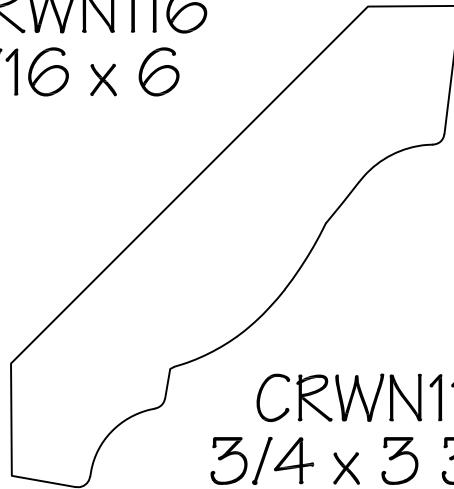

CRWN117  
3/4 x 3 3/8

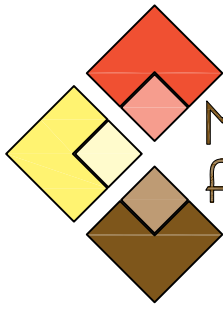

Melbourne  
Architectural  
MILLWORK COMPANY

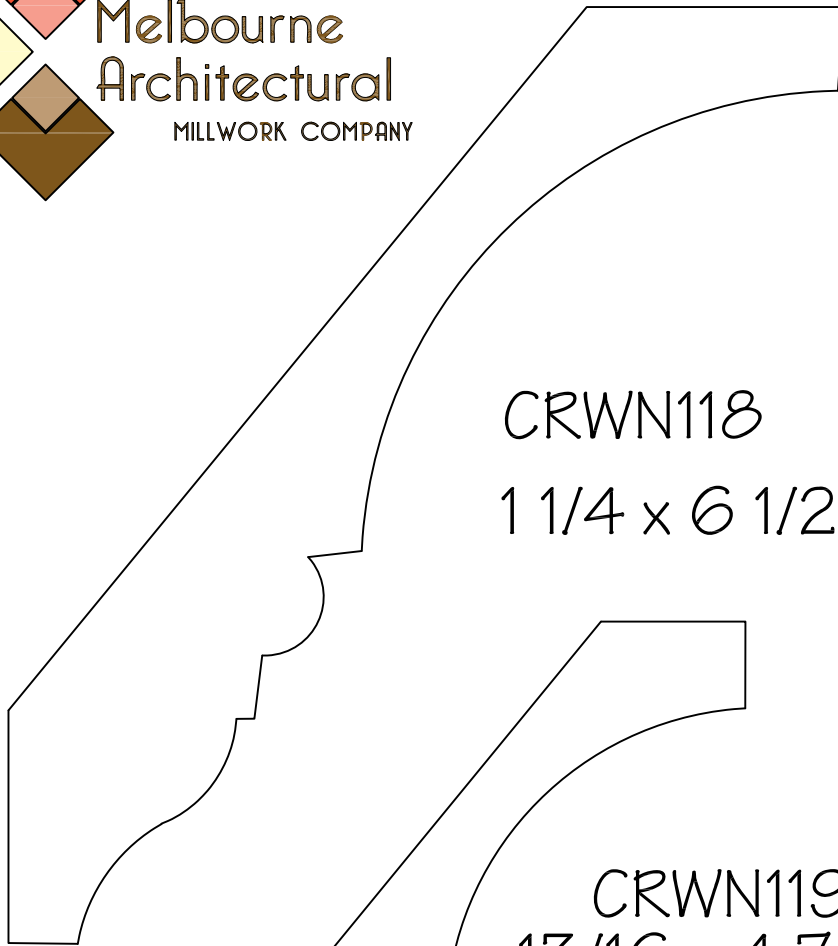

CRWN118  
 $1\frac{1}{4} \times 6\frac{1}{2}$

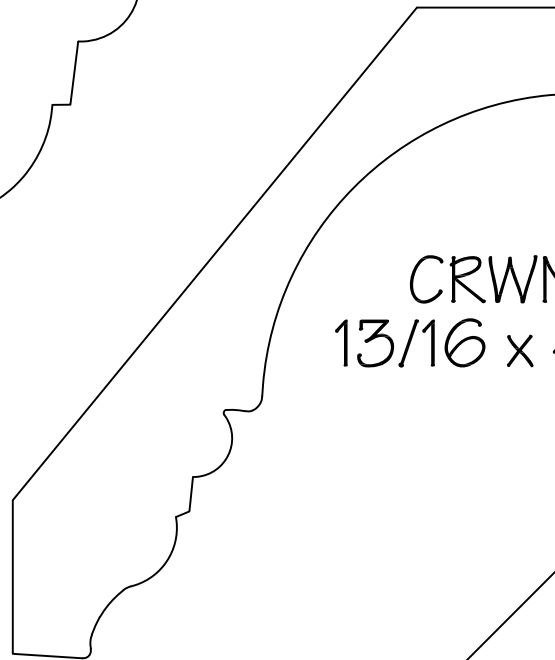

CRWN119  
 $13/16 \times 4\frac{7}{16}$

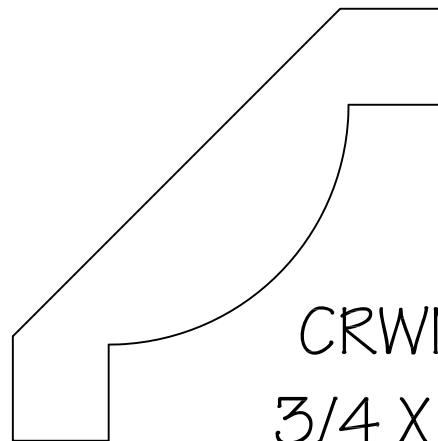

CRWN120  
 $3/4 \times 3\frac{3}{16}$

C36

325 East Drive - Melbourne, FL 32904  
321-308-3297 - Fax 321-308-3299

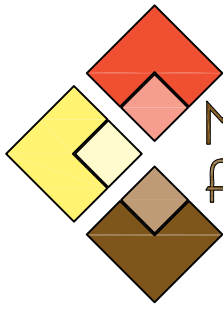

Melbourne  
Architectural  
MILLWORK COMPANY

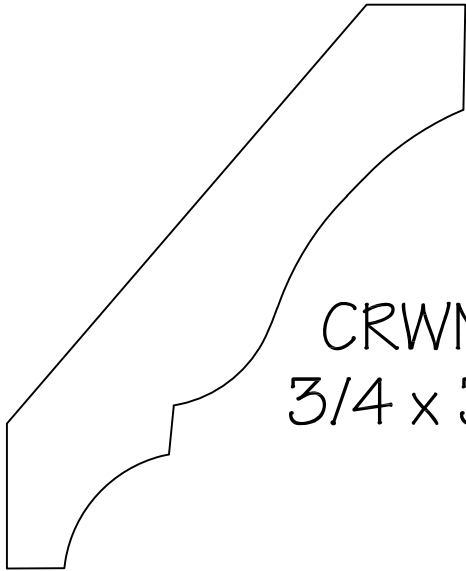

CRWN121  
 $3/4 \times 3 \ 3/4$

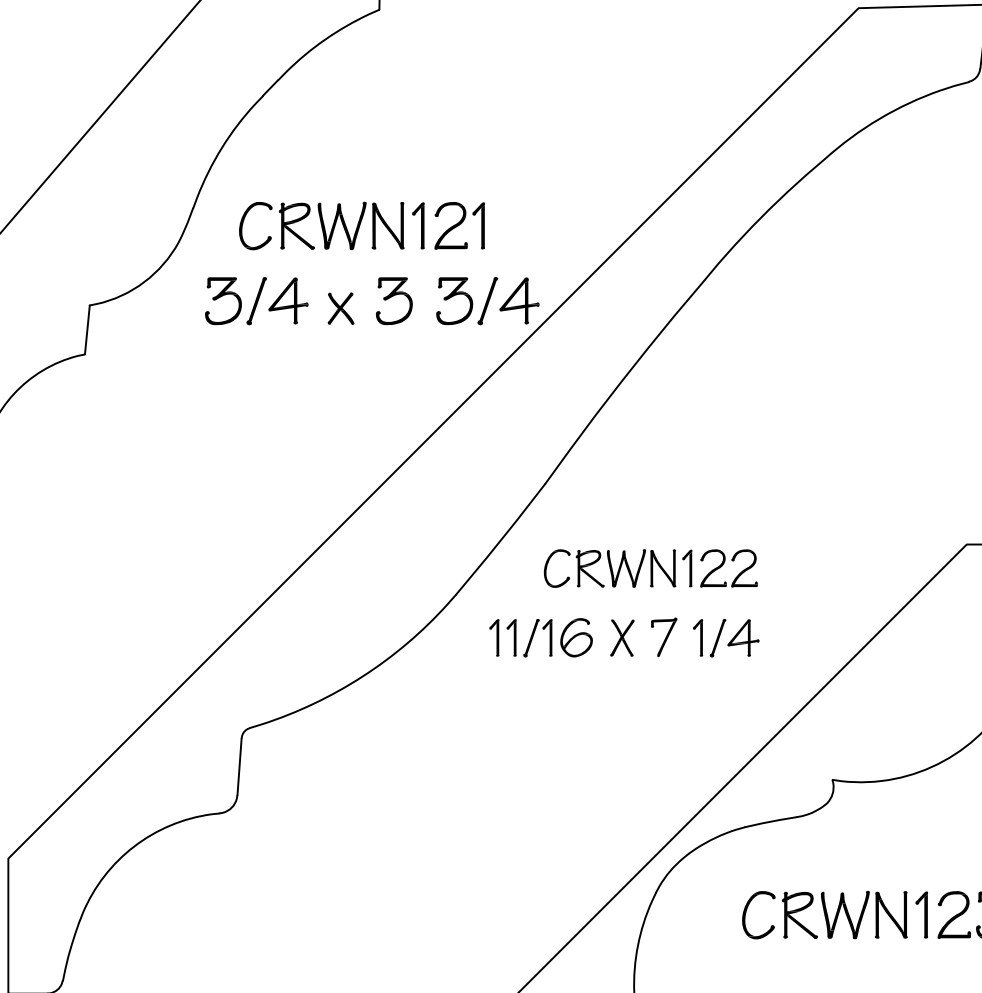

CRWN122  
 $11/16 \times 7 \ 1/4$

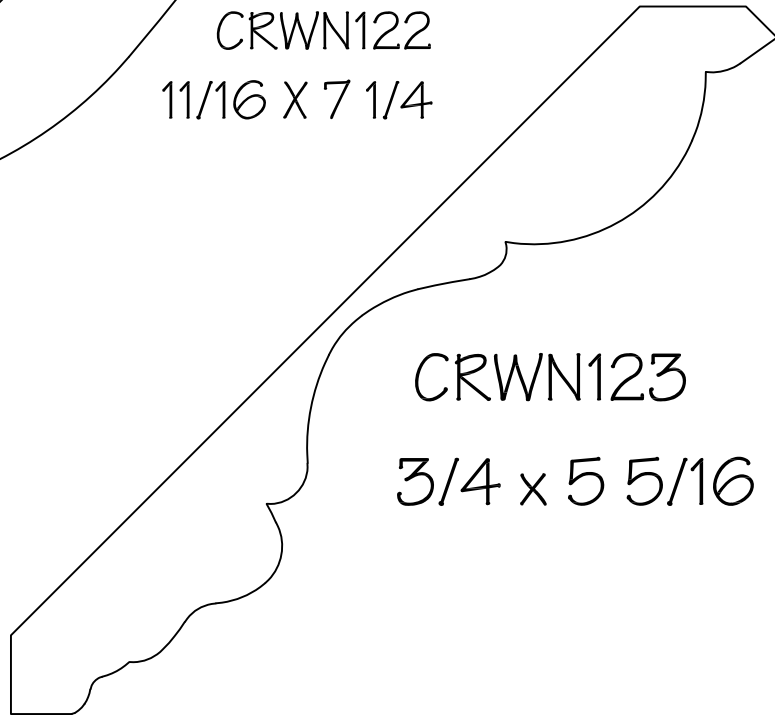

CRWN123  
 $3/4 \times 5 \ 5/16$

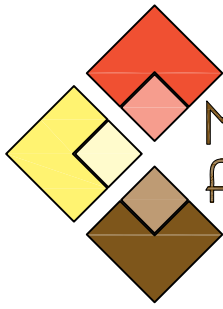

Melbourne  
Architectural  
MILLWORK COMPANY

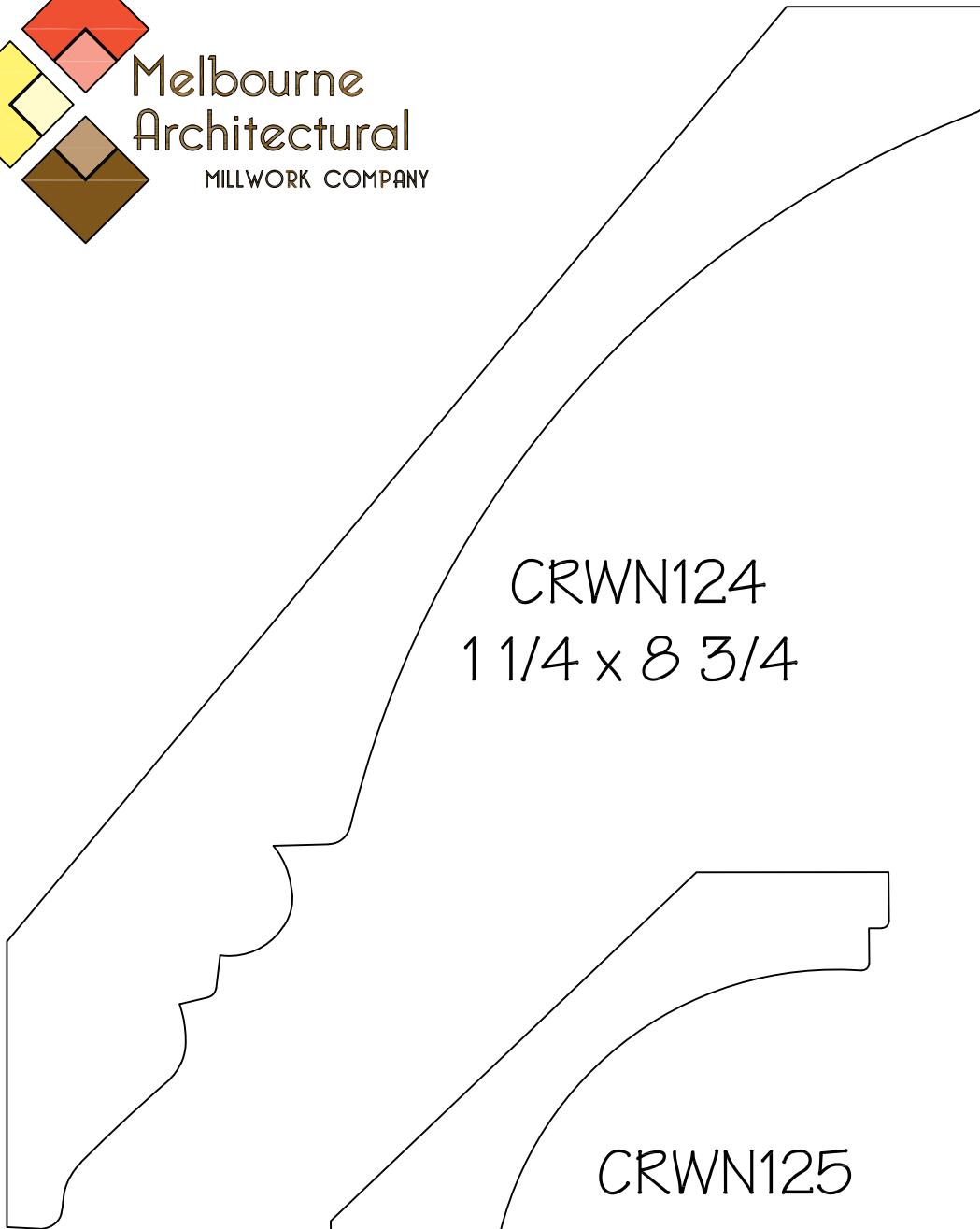

CRWN124  
1 1/4 x 8 3/4

CRWN125  
1 x 4 1/4

C38

325 East Drive - Melbourne, FL 32904  
321-308-3297 - Fax 321-308-3299

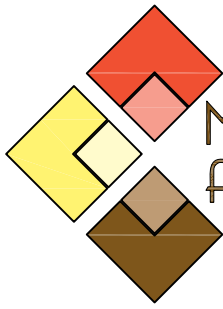

Melbourne  
Architectural  
MILLWORK COMPANY

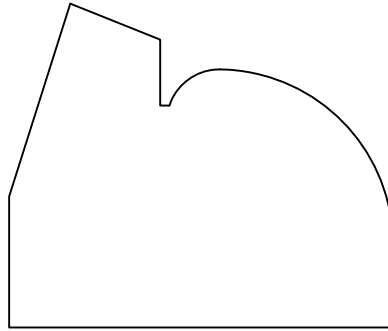

MISC001  
1 11/16" X 2"

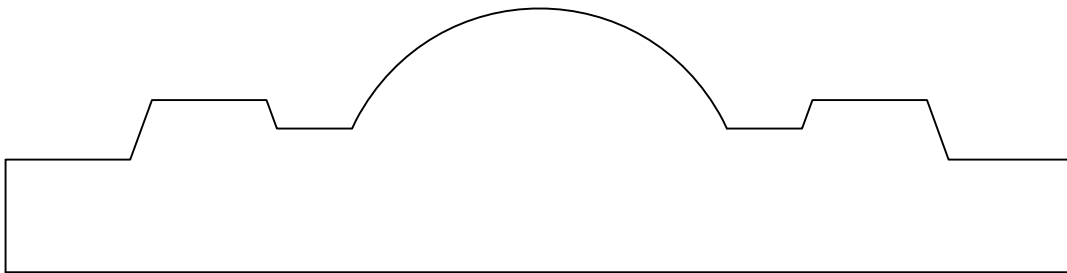

MISC002  
1 3/8" X 5 9/16"



MISC003  
3/8" X 1 1/2"

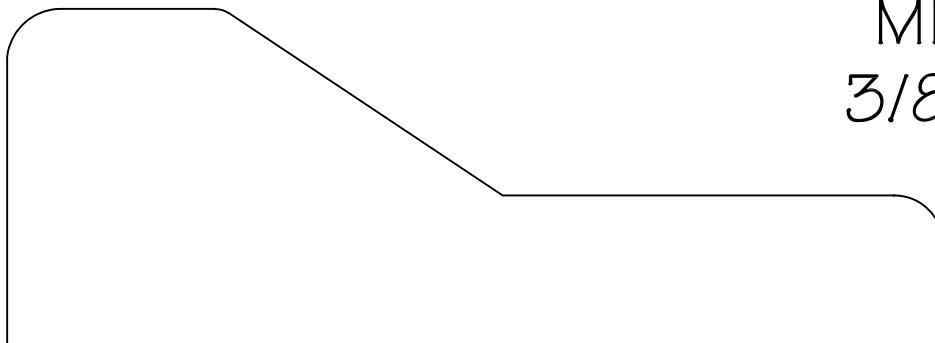

MISC004  
1 3/4" X 4 7/8"

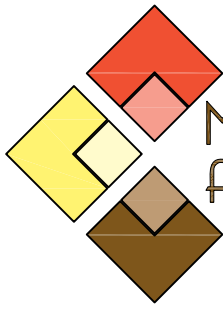

Melbourne  
Architectural  
MILLWORK COMPANY

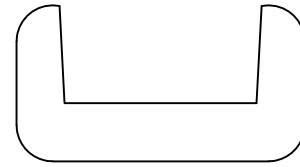

MISC006  
13/16" X 1 1/2"



MISC005  
1 1/16" X 4 3/4"



MISC007  
3/4" X 5 1/2"

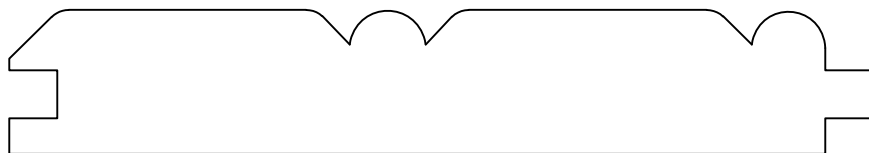

MISC008  
3/4" X 4 1/4" FACE

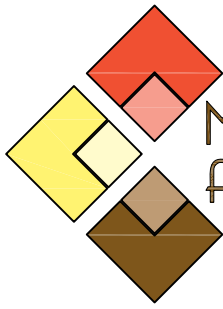

Melbourne  
Architectural  
MILLWORK COMPANY

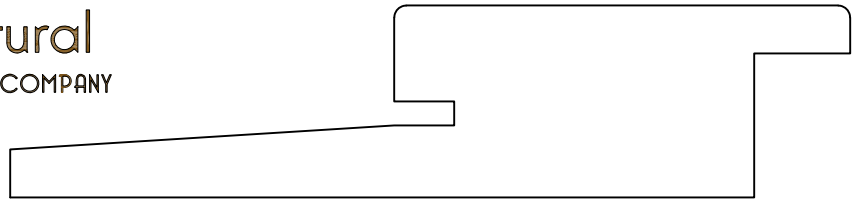

MISCO09  
1" X 4 3/8"

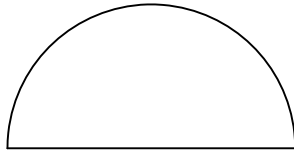

MISCO10  
3/4" X 1 1/2"

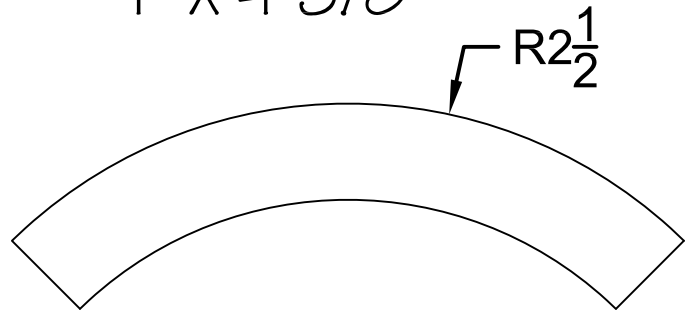

MISCO11  
1 1/16" X 3 1/2"

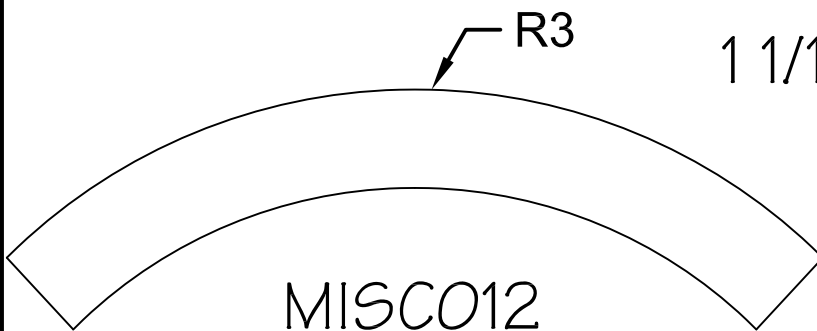

MISCO12  
1 1/4" X 4 1/4"

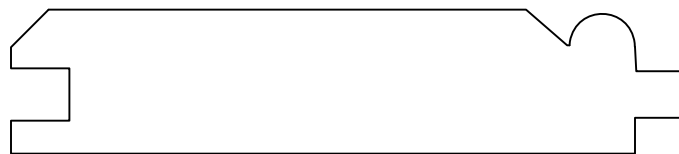

MISCO13  
3/4" X 3 1/4" FACE

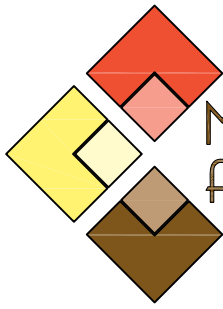

Melbourne  
Architectural  
MILLWORK COMPANY

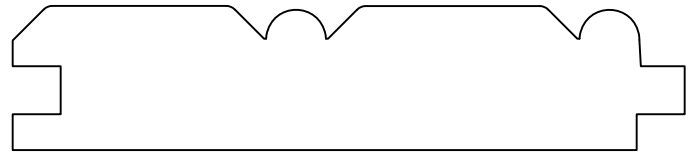

MISCO15

3/4" X 3 1/4" FACE



MISCO14

3/4" X 5 1/2" O.A.

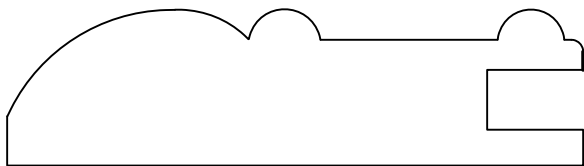

MISCO16

13/16" X 3"

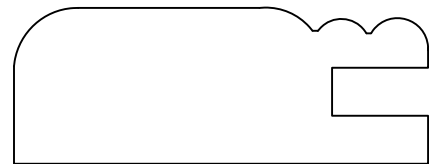

MISCO17

13/16" X 2 3/16"

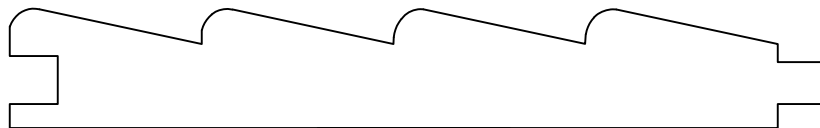

MISCO18

5/8" X 4 1/4"



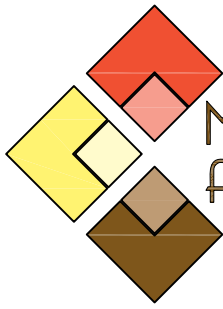

Melbourne  
Architectural  
MILLWORK COMPANY

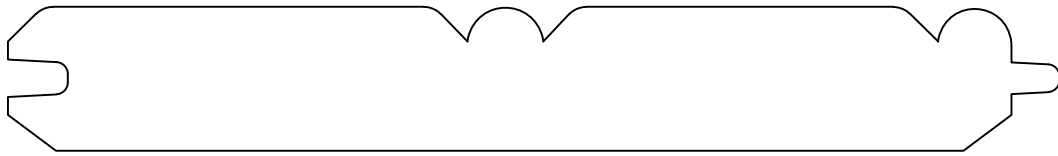

MISC019

3/4" X 5 1/2"

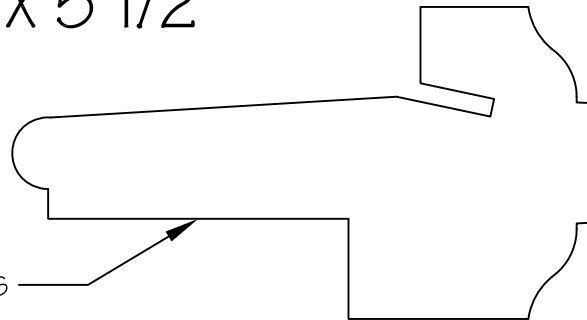

CAN BE MODIFIED FOR DOOR THICKNESS

MISC020

1 5/8" X 3 1/2"

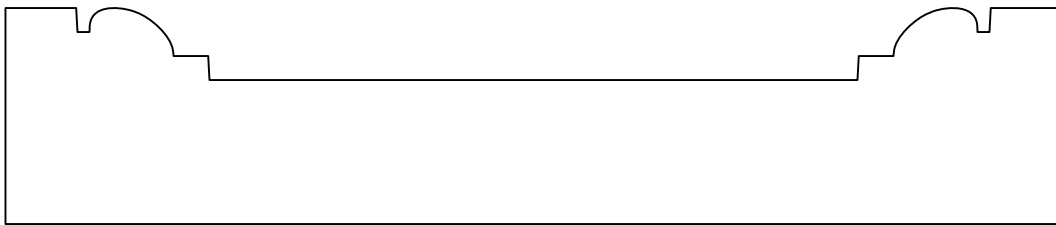

MISC021

1 1/8" X 5 1/2"

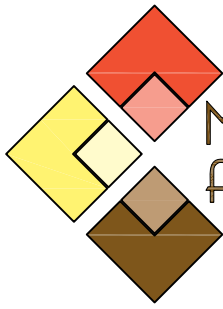

Melbourne  
Architectural  
MILLWORK COMPANY

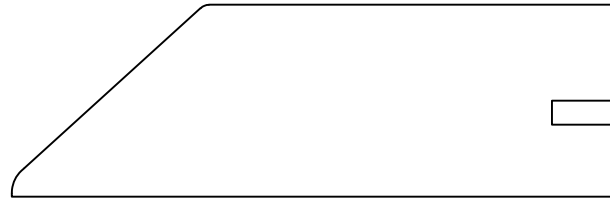

MISCO22  
1" X 3 1/8"

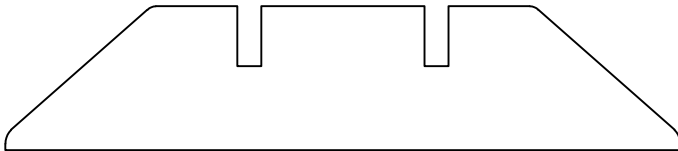

MISCO23  
3/4" X 3 1/2"

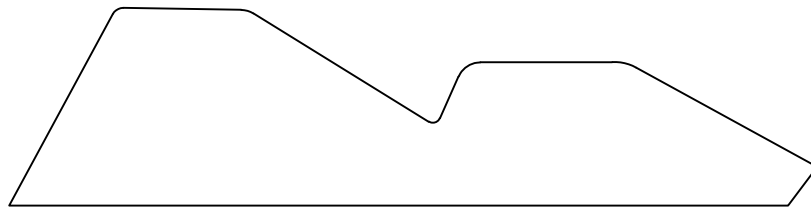

MISCO24  
1" X 4 3/16"

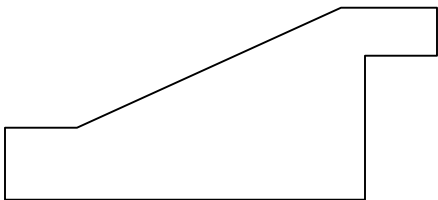

MISCO25  
1" X 2 1/4"

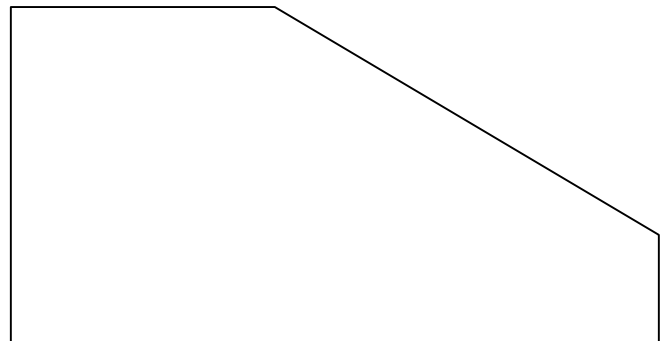

MISCO26  
1 3/4" X 3 3/8"

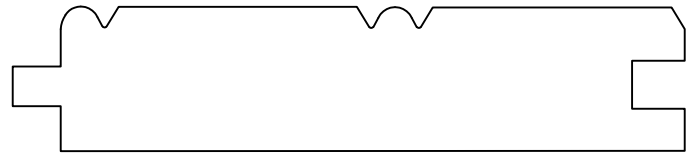

MISCO27  
3/4" X 3 1/2"

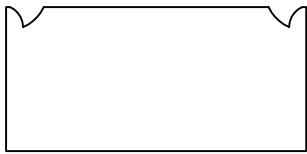

MISCO28  
3/4" X 1 9/16"

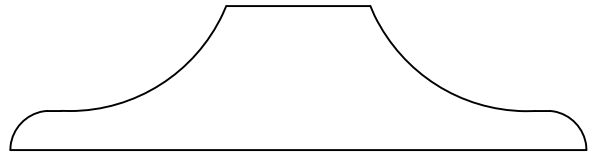

MISCO29  
3/4" X 3 "

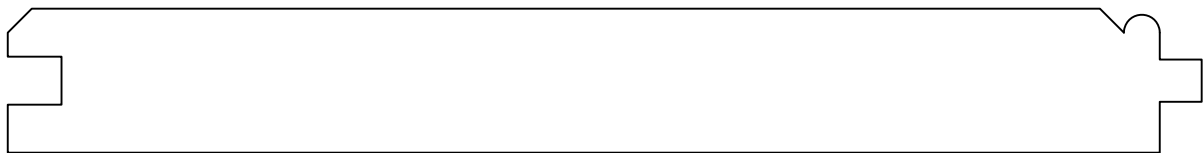

MISCO30  
3/4" x 6" Face

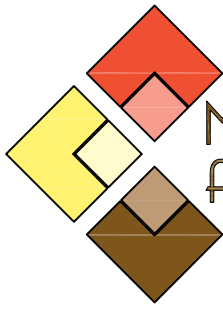

Melbourne  
Architectural  
MILLWORK COMPANY

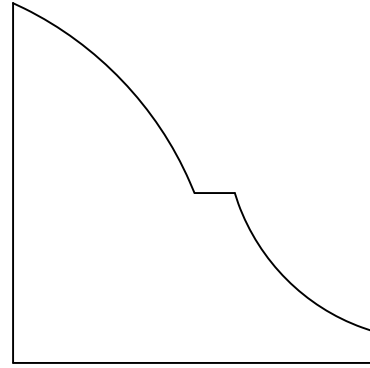

MISC031

1 7/8" x 1 7/8"

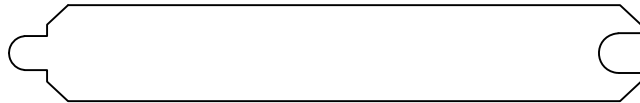

MISC032

1/2" x 3 1/8" FACE

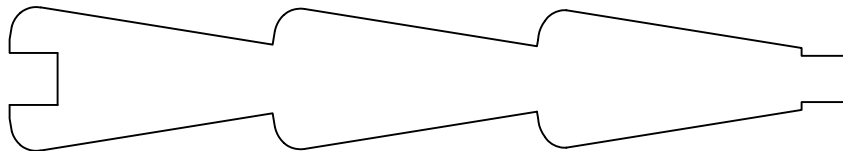

MISC033

3/4" x 4 1/8" Face

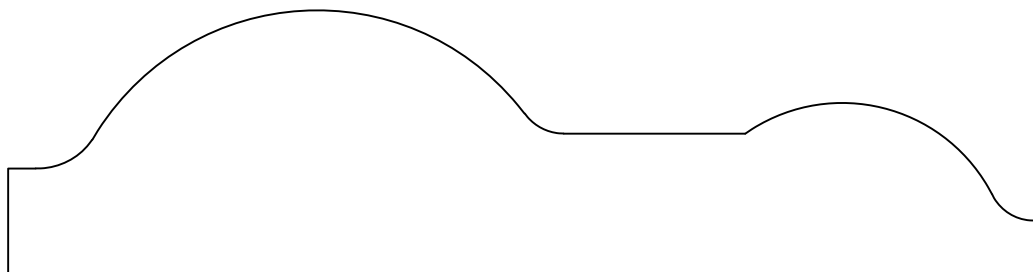

MISC034

1 3/8" x 5 3/8"

D08

325 East Drive - Melbourne, FL 32904  
321-308-3297 - Fax 321-308-3299

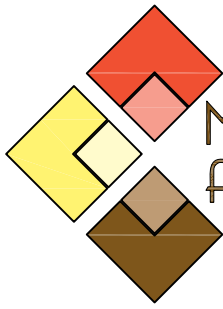

Melbourne  
Architectural  
MILLWORK COMPANY

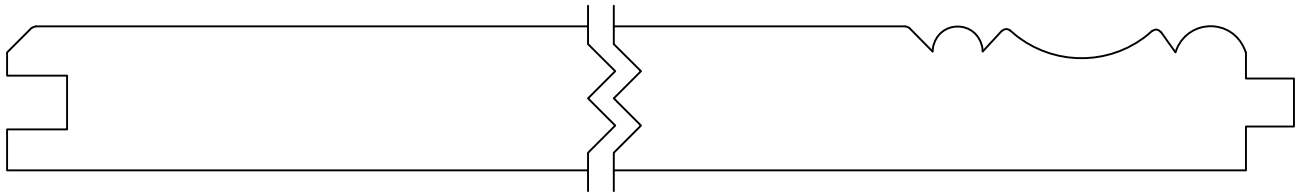

MISCO35  
3/4" x 9" FACE

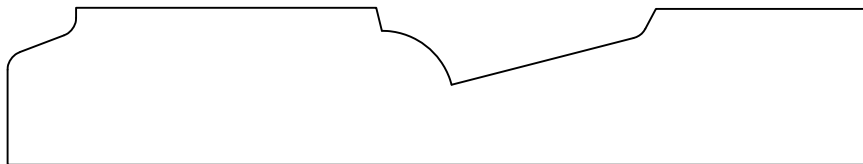

MISCO36  
13/16" x 4 1/2"

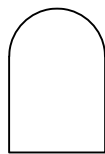

MISCO37  
3/4" x 1/2"

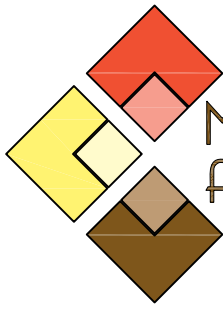

Melbourne  
Architectural  
MILLWORK COMPANY

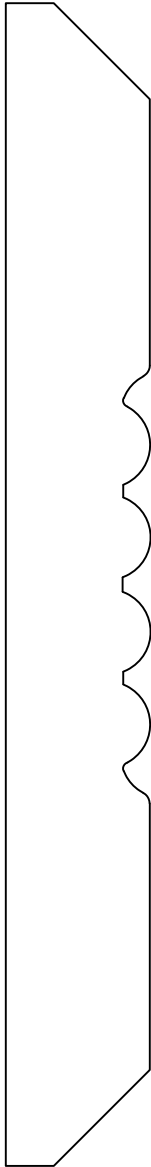

MISC039  
3/4" x 6 1/16"

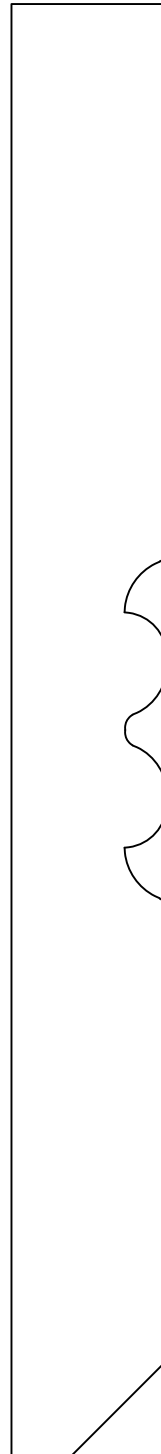

MISC038  
13/16" x 7 9/16"

D10

325 East Drive - Melbourne, FL 32904  
321-308-3297 - Fax 321-308-3299

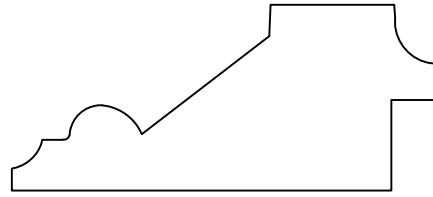

MISCO40

15/16" x 2 3/16"

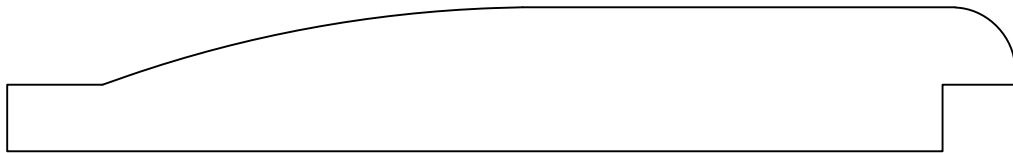

MISCO41

3/4" x 5 1/4"

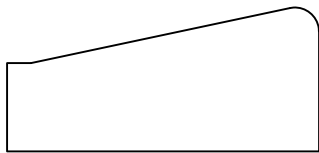

MISCO42

3/4" x 1 5/8"



MISCO43

7/16" x 3 1/4" Face



MISC044

$3/4'' \times 4 \frac{13}{16}''$  Face

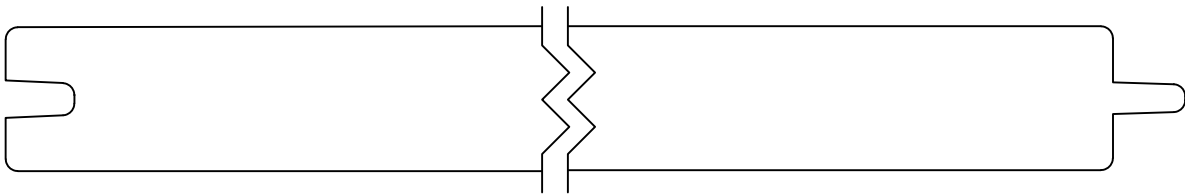

MISC046

$3/4 \times 7 \frac{1}{4}''$

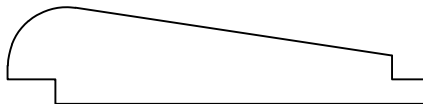

MISC047

$1/2'' \times 2 \frac{3}{16}''$



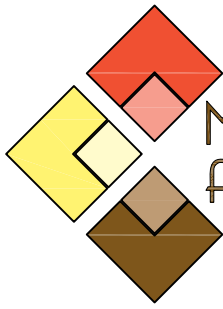

Melbourne  
Architectural  
MILLWORK COMPANY



MISC049  
3/4" x 5 7/16"

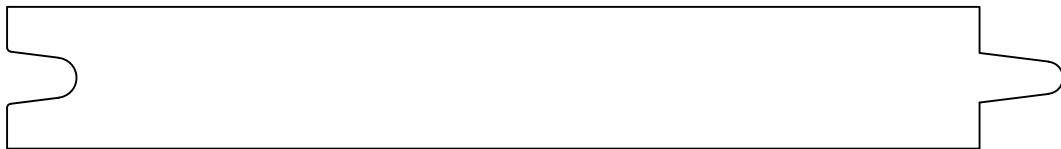

MISC050  
3/4" x VARIES

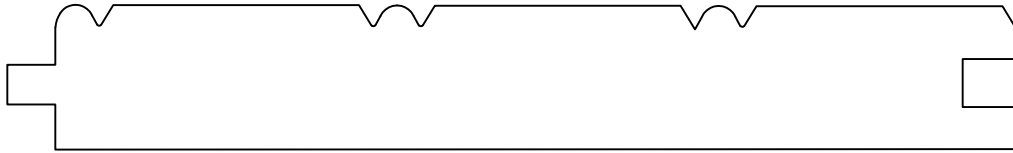

MISC051  
3/4" X 5" FACE

D14

325 East Drive - Melbourne, FL 32904  
321-308-3297 - Fax 321-308-3299

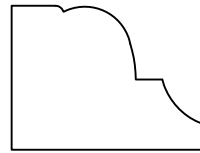

TRIM001  
3/4" X 1"



TRIM002  
9/16" X 1 1/2"

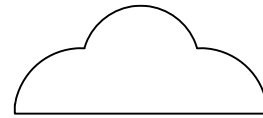

TRIM003  
9/16" X 1 5/16"

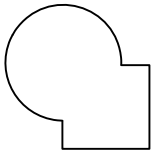

TRIM004  
3/4" X 3/4"

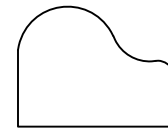

TRIM005  
5/8" X 13/16"

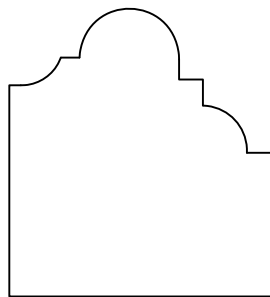

TRIM006  
1 1/2" X 1 3/8"

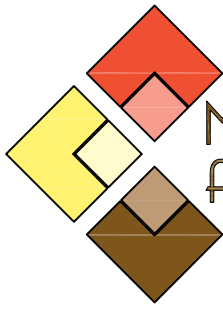

Melbourne  
Architectural  
MILLWORK COMPANY

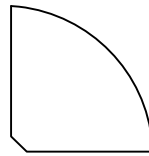

TRIM007  
3/4" X 3/4"



TRIM008  
1/2" X 1/2"

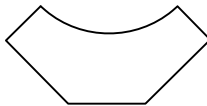

TRIM008  
3/4" X 3/4"



TRIM009  
9/16" X 1 3/4"

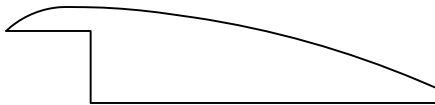

TRIM010  
1/2" X 2 1/4"

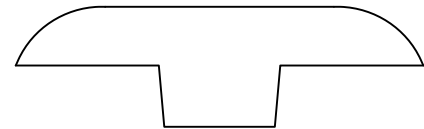

TRIM011  
5/8" X 2 1/8"

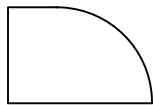

TRIM012  
1/2" X 3/4"

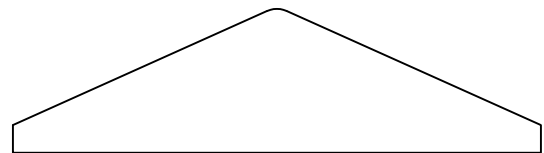

TRIM013  
3/4" X 2 3/4"

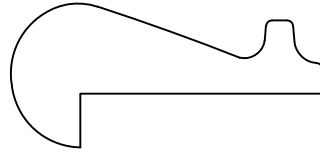

TRIM014

3/4" X 1 5/8"

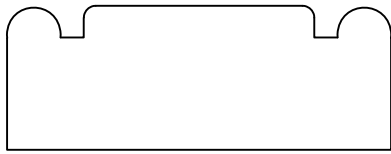

TRIM015

3/4" X 2"

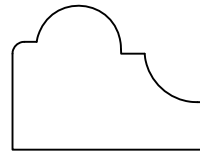

TRIM016

3/4" X 1"

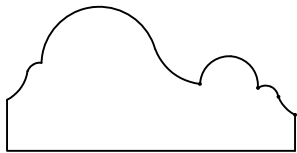

TRIM017

3/4" X 1 1/2"

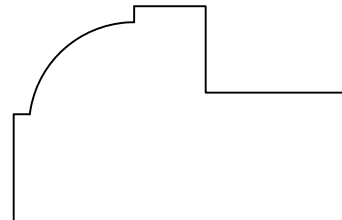

TRIM018

1 3/4" X 1 1/8"

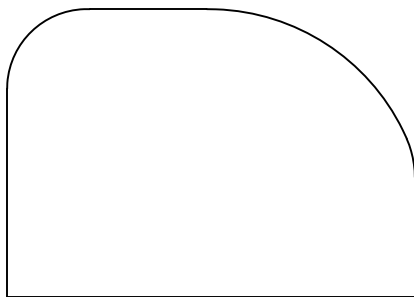

TRIM019

1 1/2" X 2 1/8"

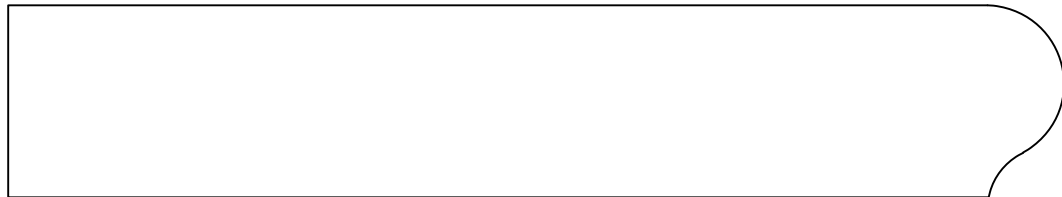

TRIM020  
1" X 5 1/2"

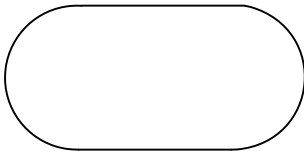

TRIM021  
3/4" X 1 9/16"

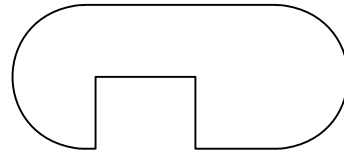

TRIM022  
3/4" X 1 3/4"

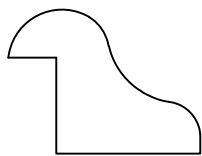

TRIM023  
3/4" X 1"

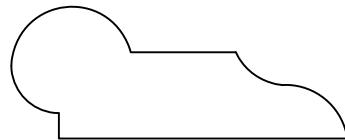

TRIM024  
11/16" X 1 3/4"

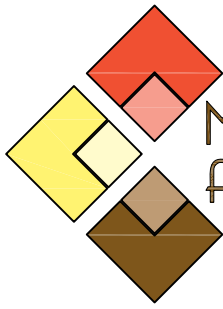

Melbourne  
Architectural  
MILLWORK COMPANY

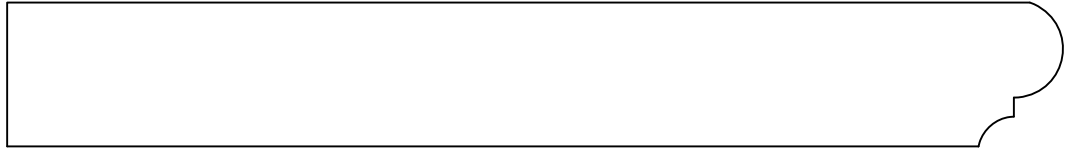

TRIM025  
3/4" X 5 1/2"

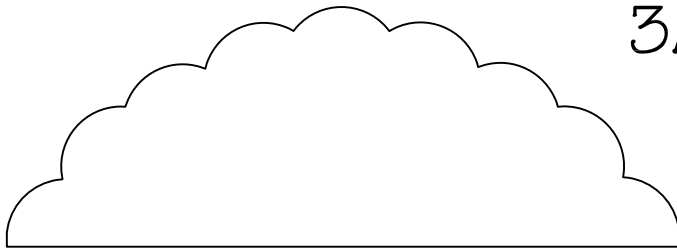

TRIM026  
1 1/4" X 3 1/2"

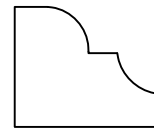

TRIM027  
5/8" X 3/4"

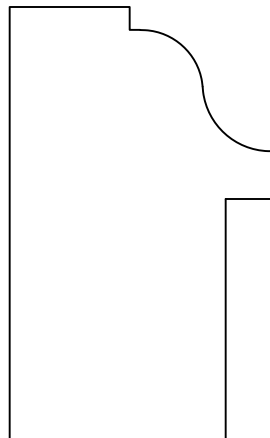

TRIM028  
1 3/8" X 2 1/4"



TRIM029  
25/32" X 2 3/4"

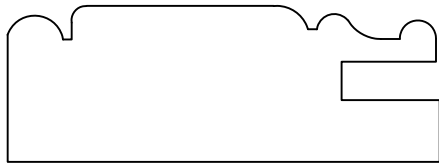

TRIM030  
13/16" X 2 1/4"



TRIM031  
13/16" X 2 1/4"

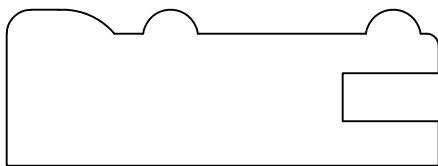

TRIM032  
13/16" X 2 1/4"

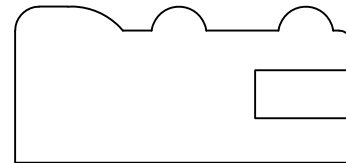

TRIM033  
13/16" X 1 3/4"



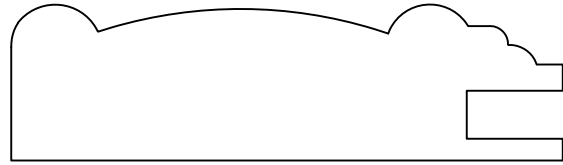

TRIM034  
13/16" X 2 7/8"

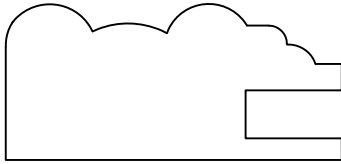

TRIM035  
13/16" X 1 3/4"

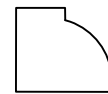

TRIM036  
1/2" X 7/16"



TRIM037  
1/4" X 1/4"



TRIM038  
3/4" X 1 1/2"

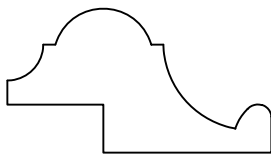

TRIM039  
3/4" X 1 3/8"

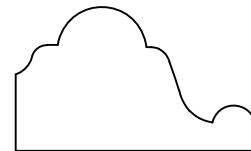

TRIM040  
3/4" X 1 1/4"

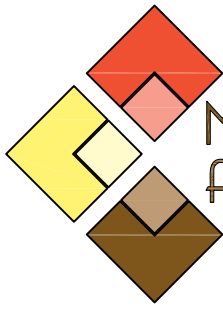

Melbourne  
Architectural  
MILLWORK COMPANY

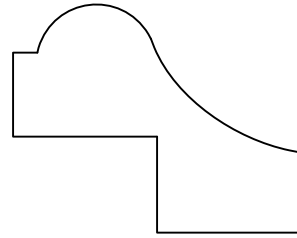

TRIM041  
1 3/16" X 1 1/2"

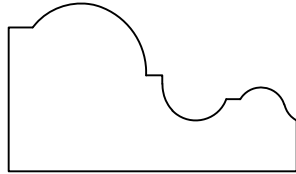

TRIM042  
7/8" X 1 1/2"

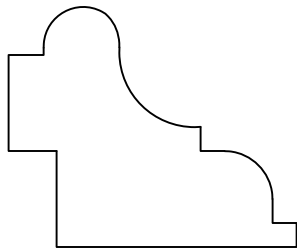

TRIM043  
1 1/4" X 1 1/2"

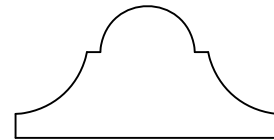

TRIM044  
11/16" X 1 3/8"

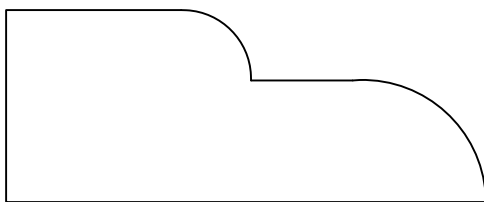

TRIM045  
1" X 2 1/2"



TRIM046  
1/2" X 1 1/4"

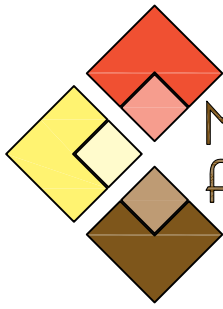

Melbourne  
Architectural  
MILLWORK COMPANY

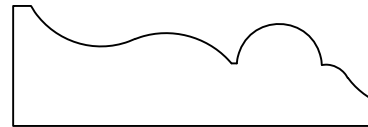

TRIM047  
5/8" X 1 7/8"

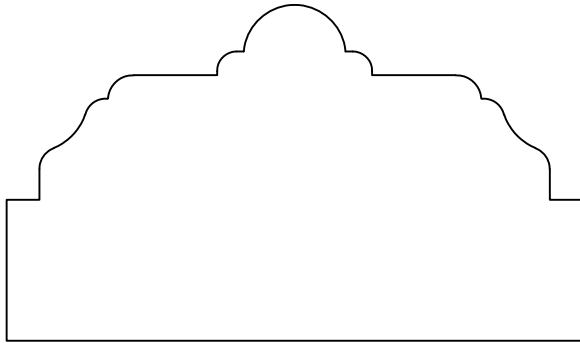

TRIM048  
1 3/4" X 3"

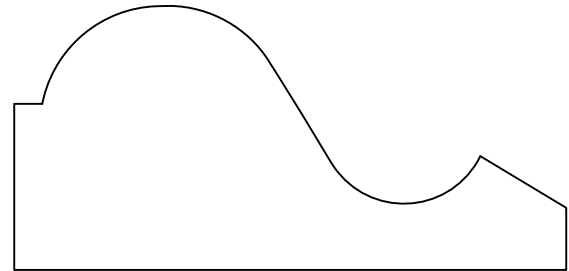

TRIM049  
1 3/8" X 2 7/8"

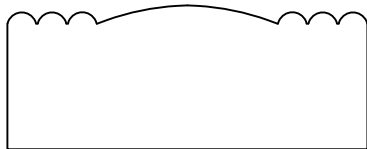

TRIM050  
3/4" X 1 7/8"

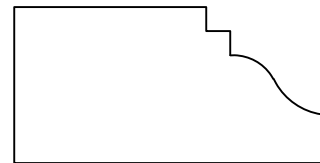

TRIM051  
13/16" X 1 5/8"

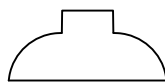

TRIM052  
3/8" X 13/16"

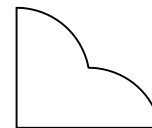

TRIM053  
5/8" X 3/4"

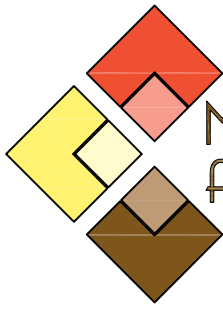

Melbourne  
Architectural  
MILLWORK COMPANY

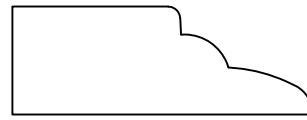

TRIM054  
9/16" x 1 9/16"

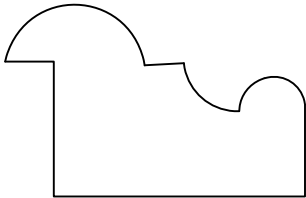

TRIM055  
1" x 1 9/16"

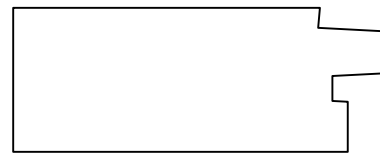

TRIM056  
3/4" x 1 15/16"

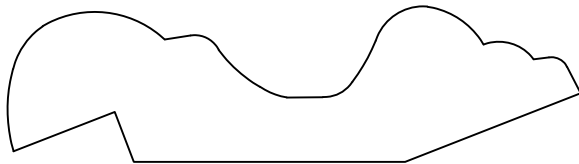

TRIM057  
13/16" x 3"

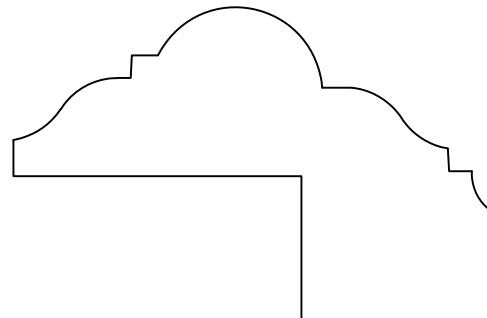

TRIM058  
1 5/8" x 2 1/2"

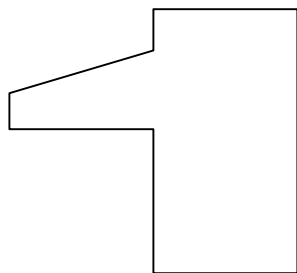

TRIM059  
1 3/8" x 1 1/2"

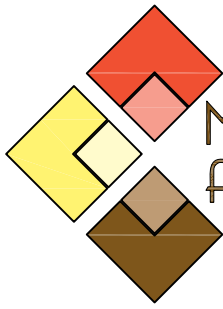

Melbourne  
Architectural  
MILLWORK COMPANY

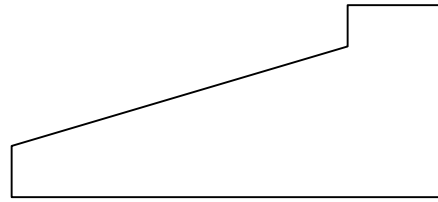

TRIM060  
1" x 2 1/4"

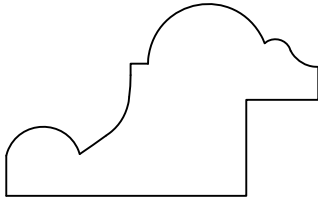

TRIM061  
1" x 1 5/8"



TRIM062  
7/16" x 3/4"

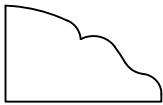

TRIM063  
1/2" x 13/16"

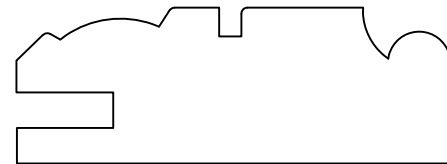

TRIM064  
13/16" x 2 1/4"

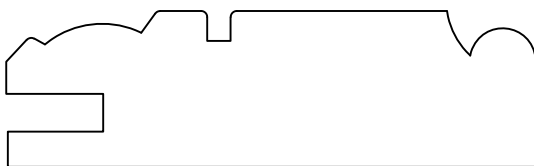

TRIM065  
13/16" x 2 3/4"

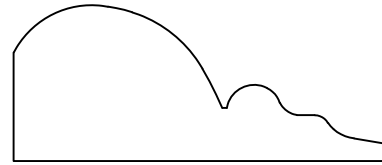

TRIM066  
13/16" x 1 15/16"

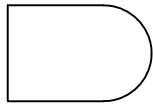

TRIM067  
1/2" x 3/4"

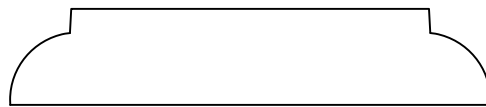

TRIM068  
1/2" x 2 1/2"

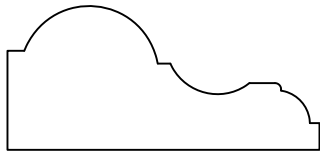

TRIM069  
3/4" x 1 5/8"

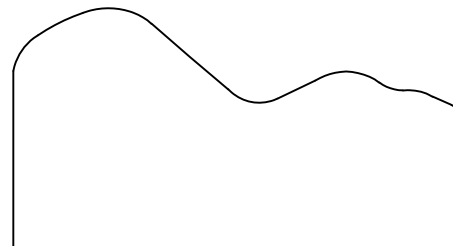

TRIM070  
1 1/4" x 2 5/16"



TRIM071  
1/2" x 1 1/4"

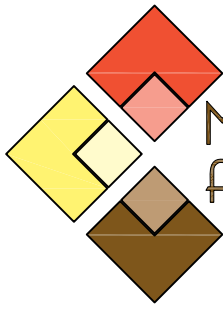

Melbourne  
Architectural  
MILLWORK COMPANY

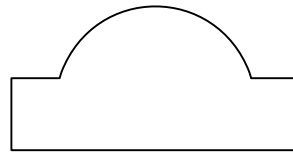

TRIM072  
3/4" x 1 1/2"



TRIM073  
5/16" x 1 1/16"

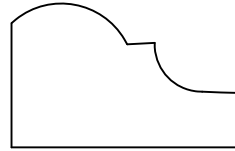

TRIM074  
3/4" x 1 3/16"



TRIM075  
3/8" x 1"



TRIM076  
1/2" x 1 5/8"



TRIM077  
1/4" x 1/2"

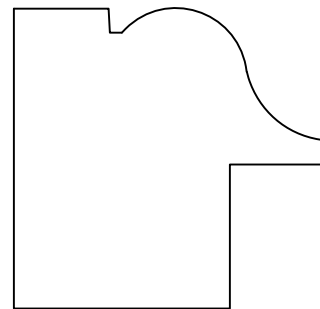

TRIM078  
1 9/16" x 1 5/8"

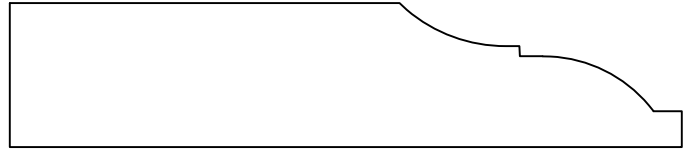

TRIM079  
3/4" x 3 1/2"

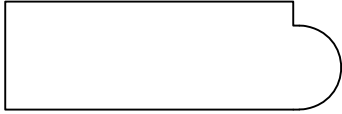

TRIM080  
9/16" x 1 3/4"



TRIM081  
3/8" x 1 7/16"

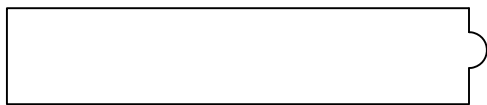

TRIM082  
1/2" x 2 1/2"

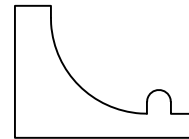

TRIM083  
11/16" x 15/16"

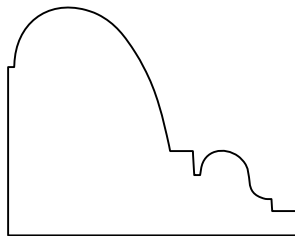

TRIM084  
1 3/16" x 1 1/2"

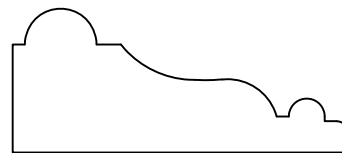

TRIM085  
3/4" x 1 3/4"



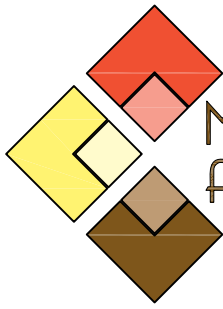

Melbourne  
Architectural  
MILLWORK COMPANY

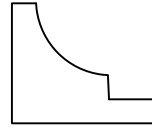

TRIM086  
5/8" X 3/4"

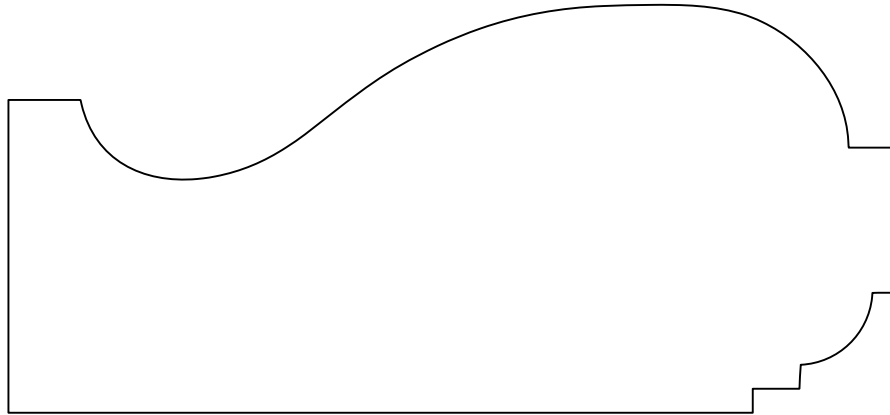

TRIM087  
2 1/8" X 4 5/8"

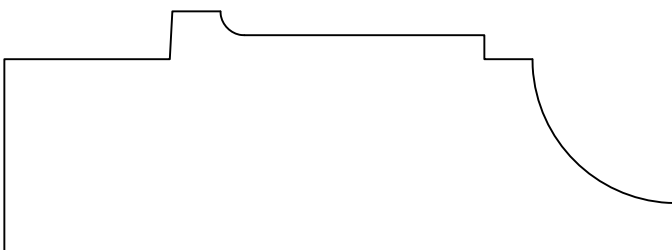

TRIM088  
1 1/4" X 3 1/2"

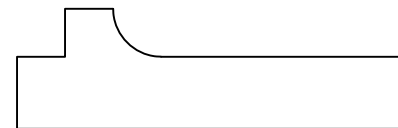

TRIM089  
5/8" X 2"

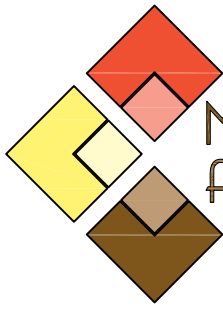

Melbourne  
Architectural  
MILLWORK COMPANY

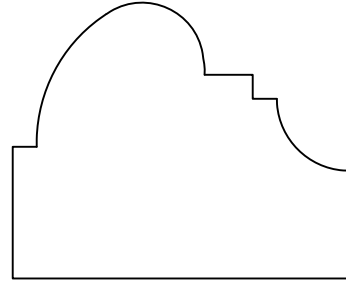

TRIM090  
1 7/16" X 1 3/4"

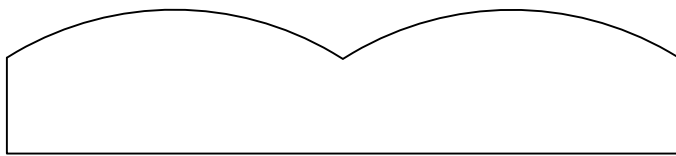

TRIM091  
3/4" X 3 1/2"

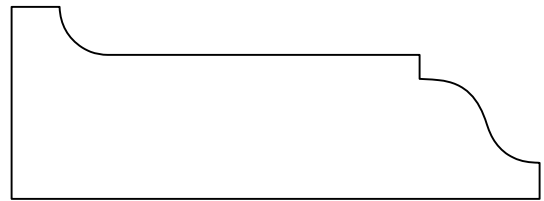

TRIM092  
1" X 2 3/4"

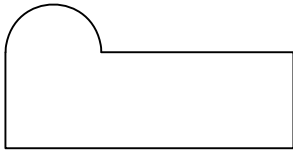

TRIM093  
3/4" x 1 1/2"

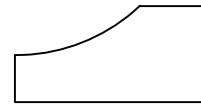

TRIM094  
1/2" x 1"

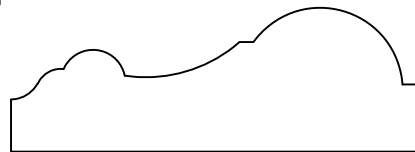

TRIM095  
3/4" x 2 1/8"

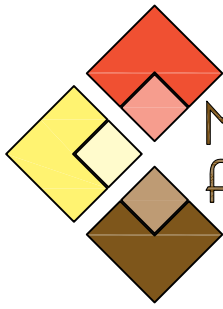

Melbourne  
Architectural  
MILLWORK COMPANY



TRIM097  
1/2" x 2 5/8"

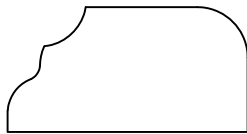

TRIM099  
5/8" x 1 1/4"

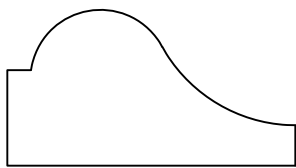

TRIM101  
13/16" x 1 1/2"

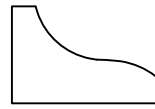

TRIM096  
1/2" x 3/4"

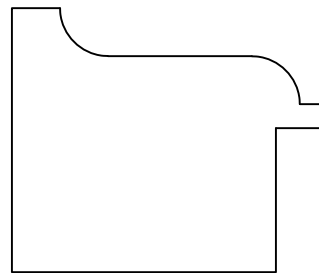

TRIM098  
1 3/8" x 1 5/8"

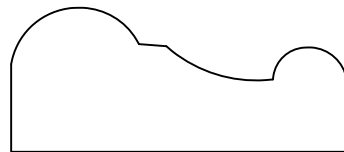

TRIM100  
3/4" x 1 3/4"

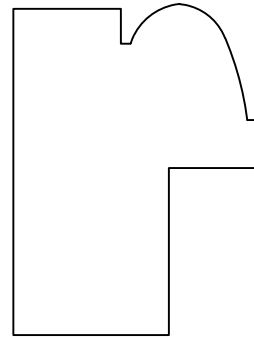

TRIM102

1 11/16" x 1 1/4"

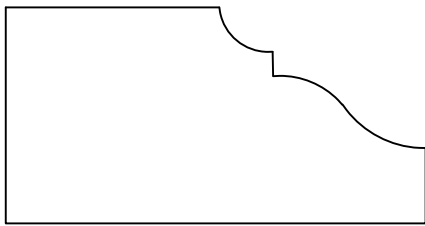

TRIM103

1 1/8" x 2 3/16"

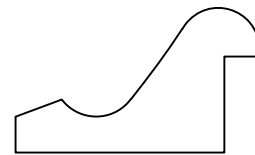

TRIM104

3/4" x 1 1/4"



TRIM105

1/4" x 3/8"

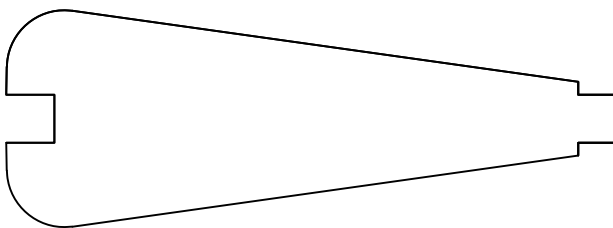

TRIM106

1 1/8" x 3 3/16"



TRIM107

9/16" x 1"

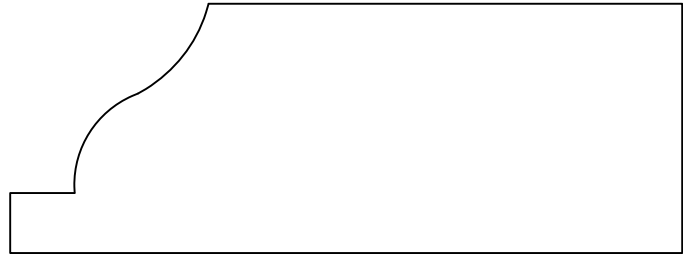

TRIM108  
1 5/16" x 3 1/2"

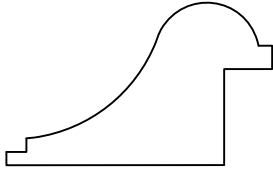

TRIM109  
7/8" x 1 3/8"

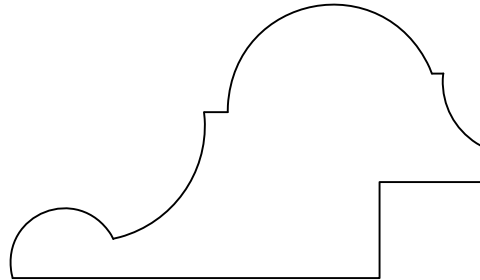

TRIM110  
1 7/16" x 2 7/16"

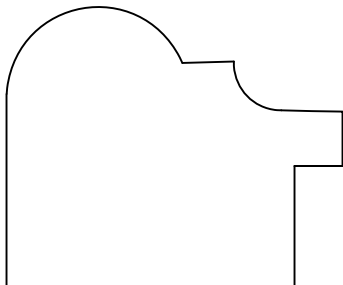

TRIM111  
1 7/16" x 1 3/4"

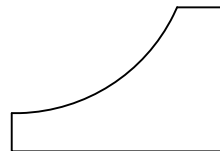

TRIM112  
3/4" x 1 1/8"

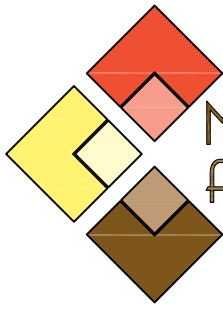

Melbourne  
Architectural  
MILLWORK COMPANY

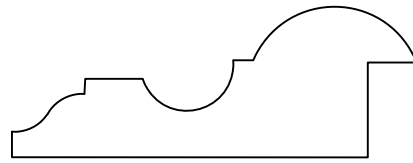

TRIM113

$13/16'' \times 2\ 1/8''$



Trim #114

$5/8'' \times 3\ 1/2''$

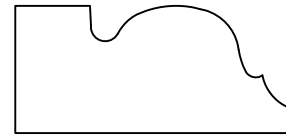

TRIM115

$1\ 7/16'' \times 11/16''$

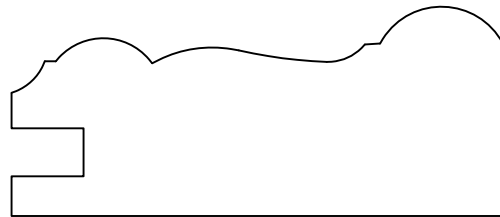

TRIM116

$1\ 11/16'' \times 2\ 9/16''$

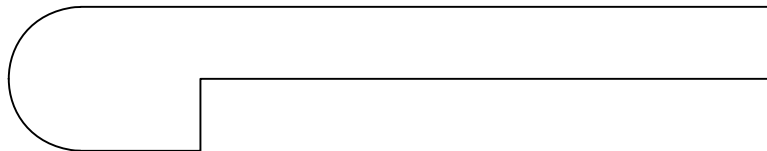

TRIM117

$3/4'' \times 4''$

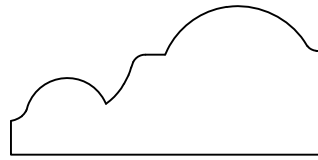

TRIM118  
3/4" x 1 5/8"

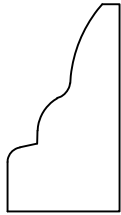

TRIM119  
1 1/16" x 9/16"

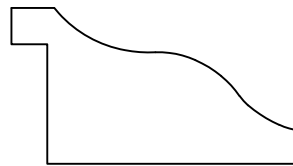

TRIM120  
13/16" x 1 1/2"

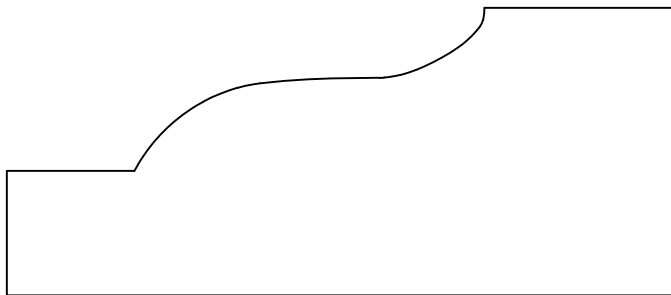

TRIM121  
1 1/2" x 3 1/2"

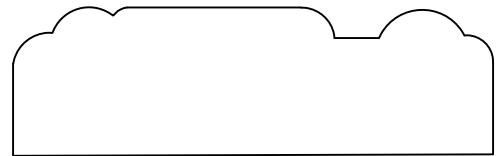

TRIM122  
3/4" x 2 1/2"

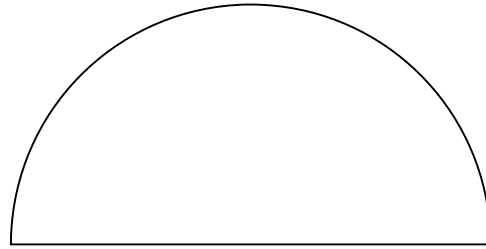

TRIM 123  
1 1/4" x 2 1/2"



TRIM124  
5/16" x 7/8"

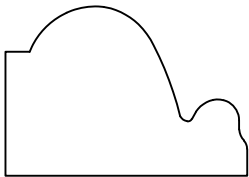

TRIM125  
7/8" x 1 1/4"

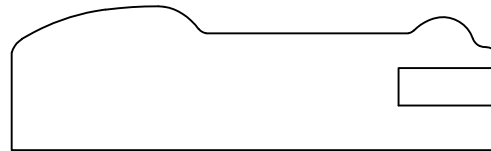

TRIM126  
3/4" x 2 1/2"

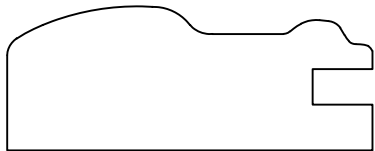

TRIM126  
3/4" x 1 7/8"

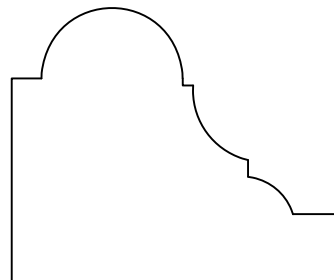

TRIM128  
1 7/16" x 1 3/4"



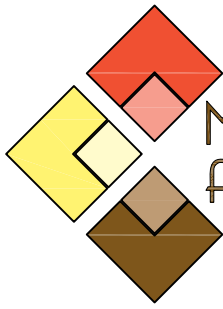

Melbourne  
Architectural  
MILLWORK COMPANY

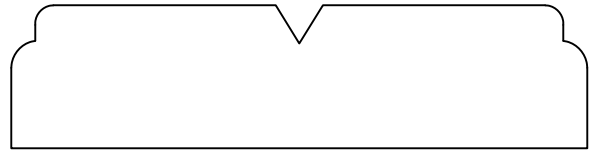

TRIM129  
3/4" x 3"



TRIM130  
5/8" x VARIES

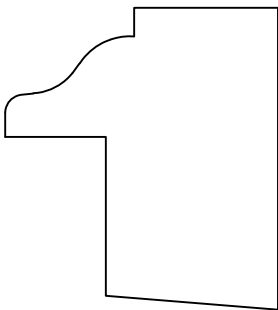

TRIM131  
1 1/4" x 1 3/16"

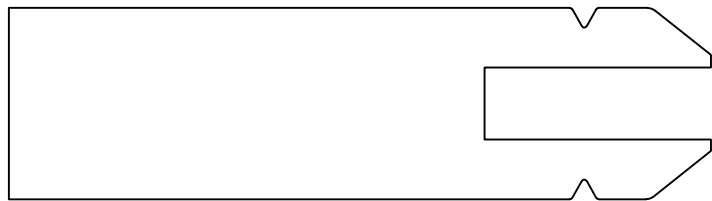

TRIM132  
1" x 3 11/16"

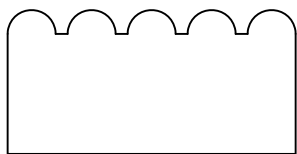

TRIM133  
3/4" x 1 1/2"



TRIM134  
5/16" x 5/8"

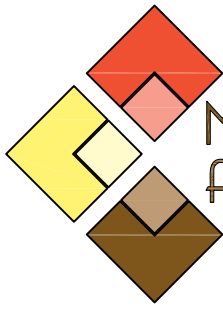

Melbourne  
Architectural  
MILLWORK COMPANY

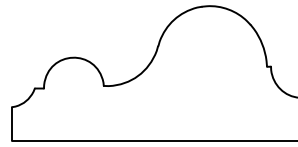

TRIM135  
3/4" X 1 1/2"

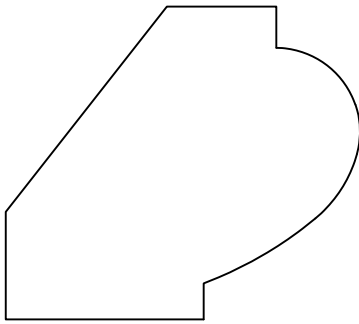

TRIM136  
1 7/8" X 1 5/8"

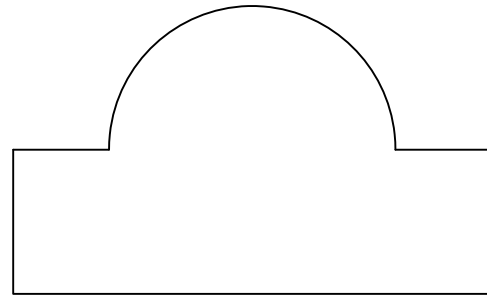

TRIM137  
1 1/2" X 2 1/2"

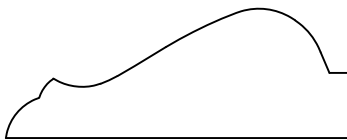

TRIM138  
1 3/4" X 5/8"

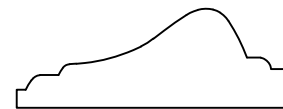

TRIM139  
1 3/8" X 1/2"

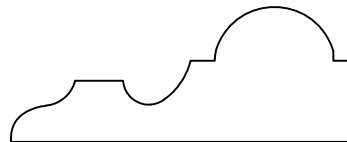

TRIM140  
3/4" x 1 3/4"

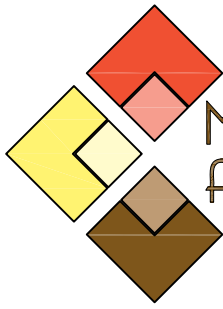

Melbourne  
Architectural  
MILLWORK COMPANY

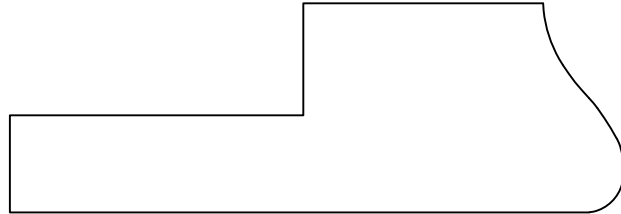

TRIM141  
1 1/16" x 3 3/16"



TRIM142  
13/16" x 3 5/8"

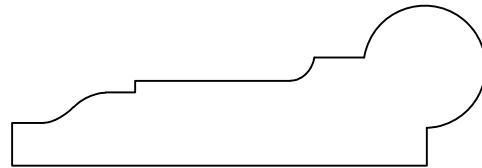

TRIM143  
13/16" x 2 7/16"

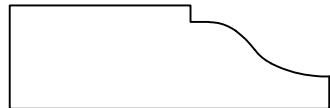

TRIM144  
9/16" x 1 11/16"

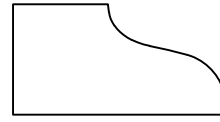

TRIM145  
9/16" x 1 1/8"

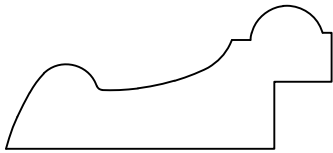

TRIM146  
3/4" x 1 11/16"

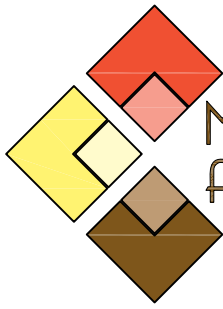

Melbourne  
Architectural  
MILLWORK COMPANY

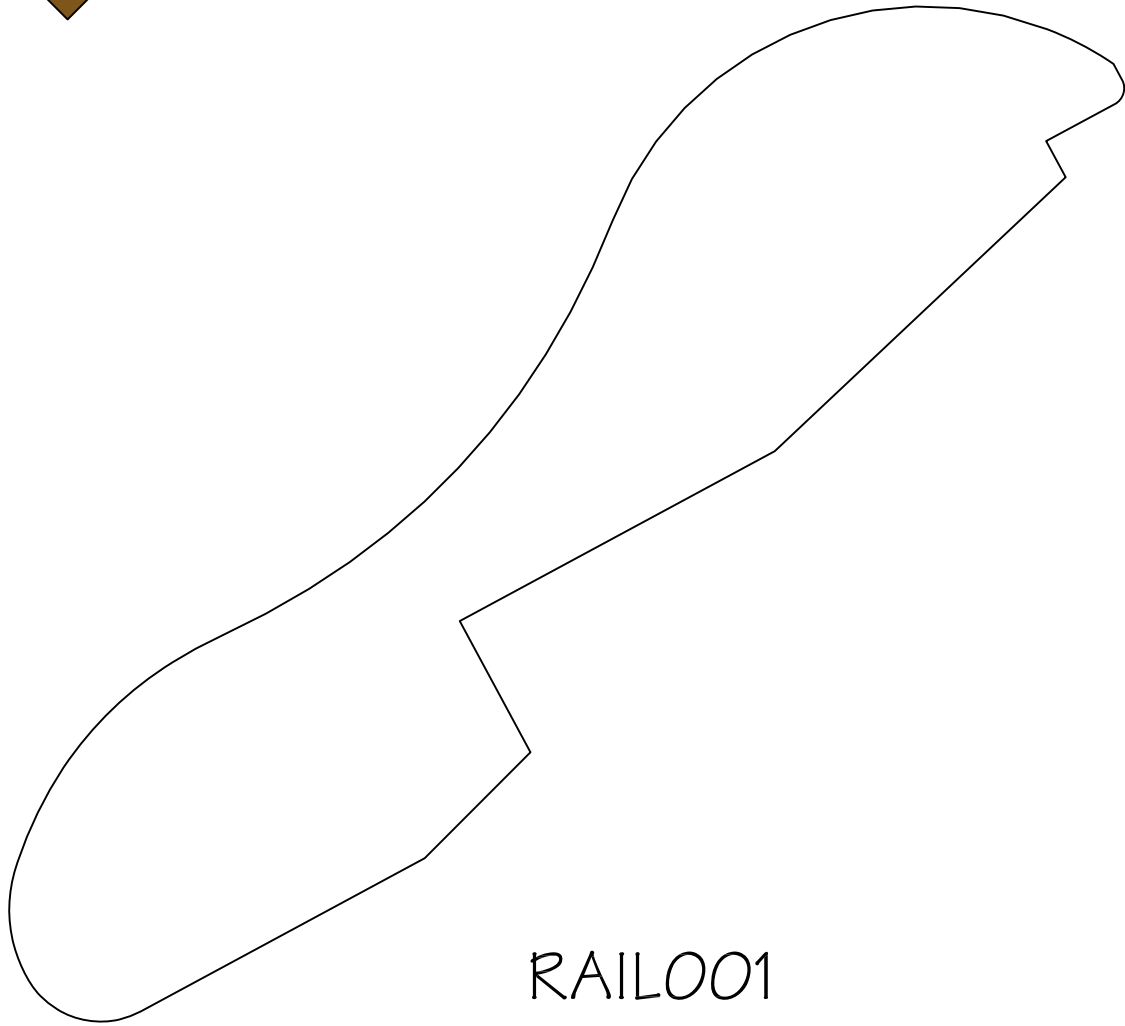

RAILOO1  
1 3/4" X 7 3/8"

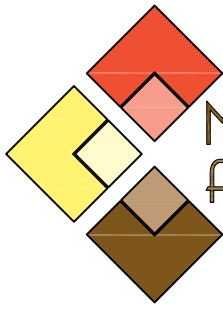

Melbourne  
Architectural  
MILLWORK COMPANY



HRAILO02  
1 3/4" X 3"

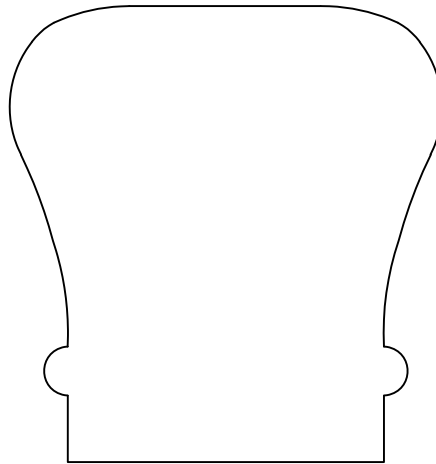

RAILO03  
2 3/8" X 2 1/4"

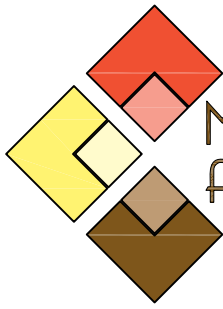

Melbourne  
Architectural  
MILLWORK COMPANY

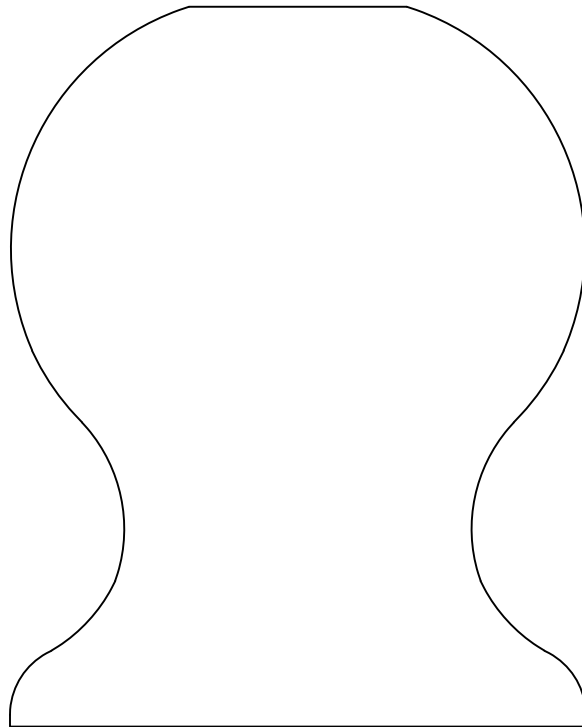

RAILO04  
3 3/4" X 3"

325 East Drive - Melbourne, FL 32904  
321-308-3297 - Fax 321-308-3299

F03

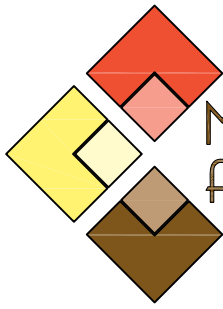

Melbourne  
Architectural  
MILLWORK COMPANY

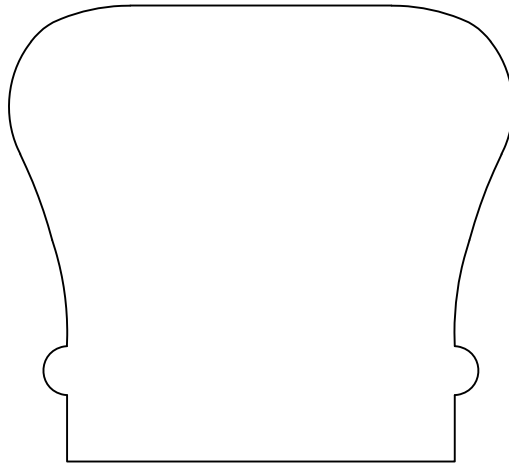

RAILO05  
2 3/8" X 2 5/8"

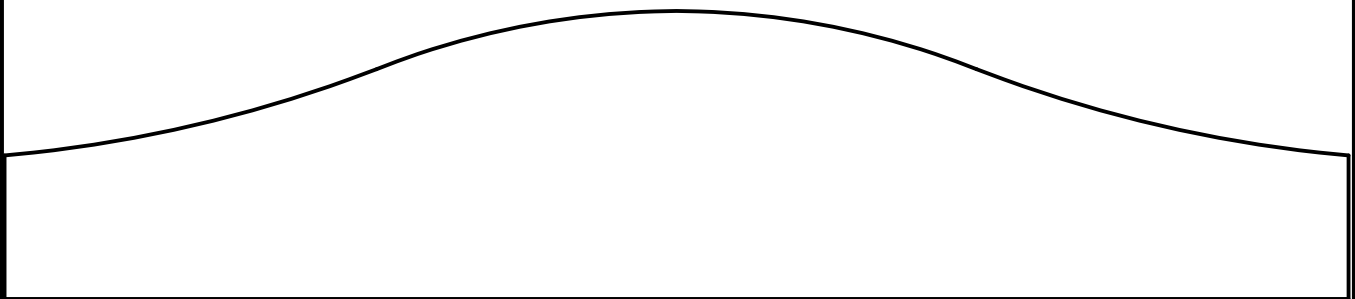

RAILO06  
1 1/2" X 7"

F04

325 East Drive - Melbourne, FL 32904  
321-308-3297 - Fax 321-308-3299



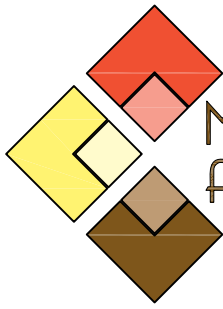

Melbourne  
Architectural  
MILLWORK COMPANY

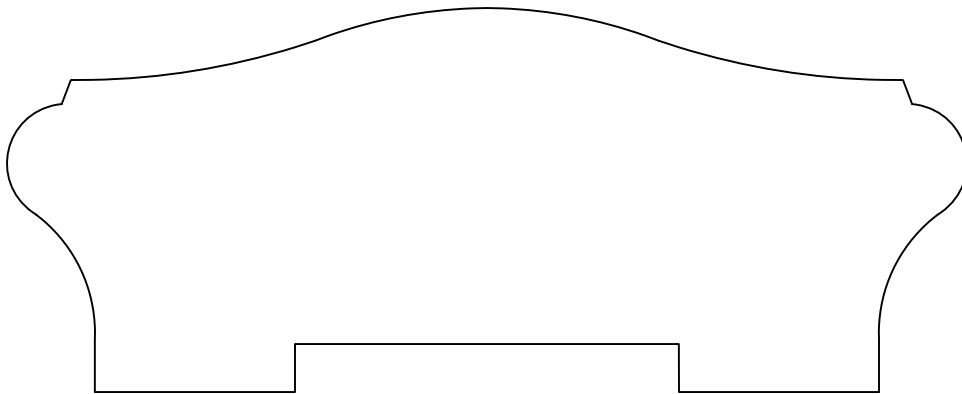

RAILO07  
2" X 5"

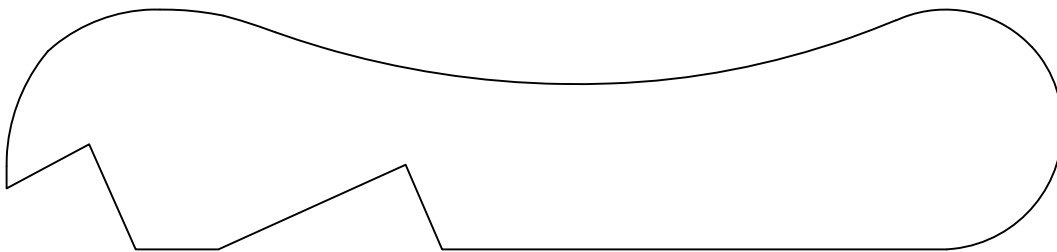

HRAILO08  
1 1/4" X 5 1/2"

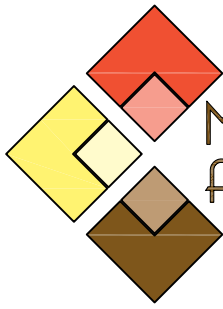

Melbourne  
Architectural  
MILLWORK COMPANY

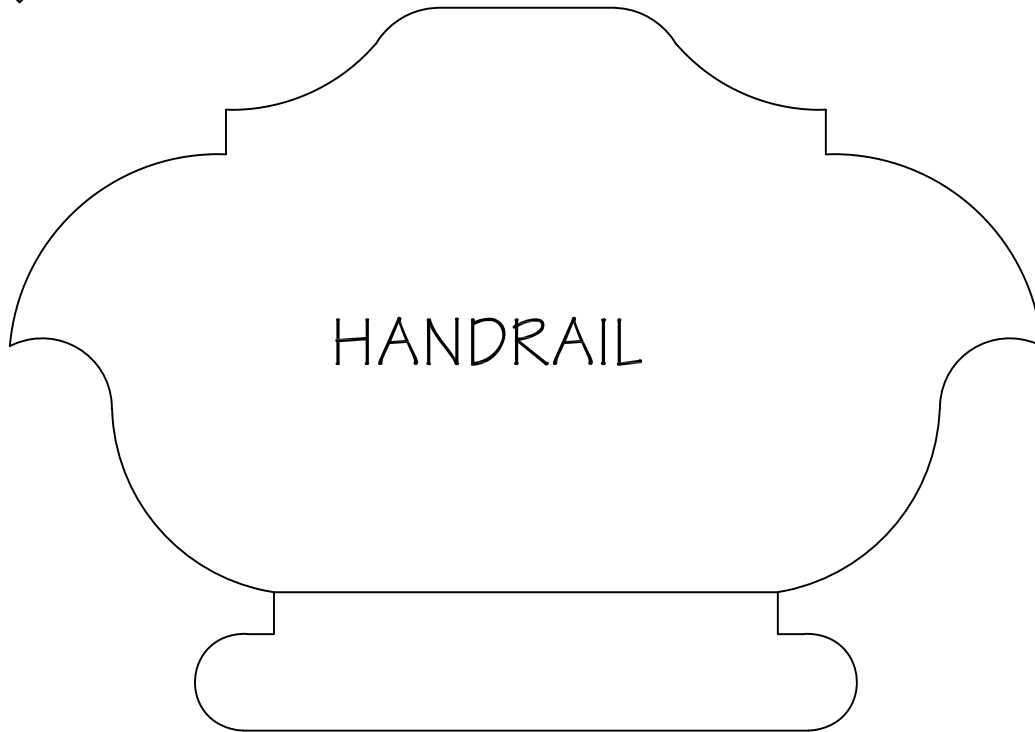

RAILO09 3 3/4" X 5 3/8"

SHOERAIL 2" X 3 15/16"



F06

325 East Drive - Melbourne, FL 32904  
321-308-3297 - Fax 321-308-3299

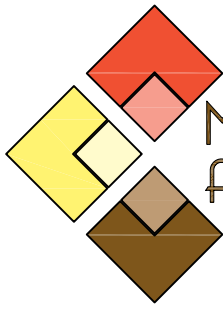

Melbourne  
Architectural  
MILLWORK COMPANY

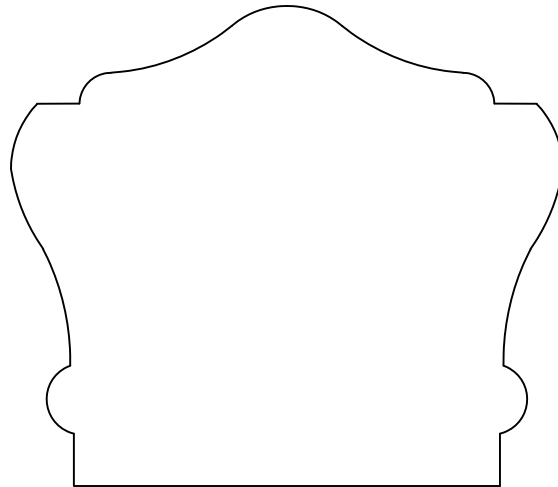

RAILO10  
2 1/2" X 2 7/8"

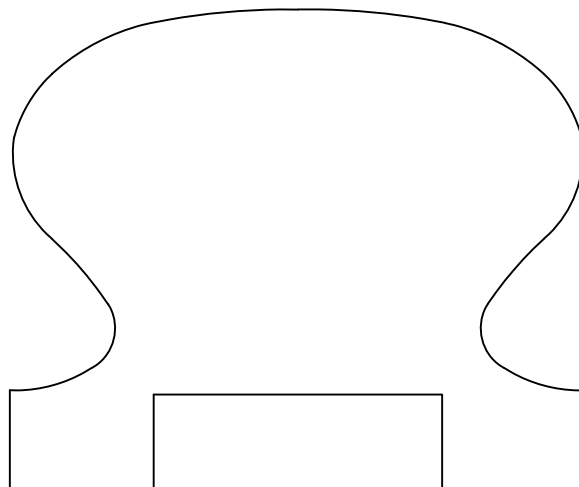

RAILO11  
2 1/2" X 3"

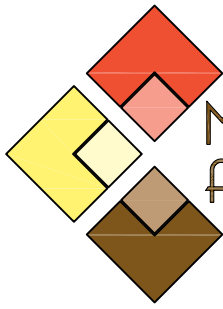

Melbourne  
Architectural  
MILLWORK COMPANY

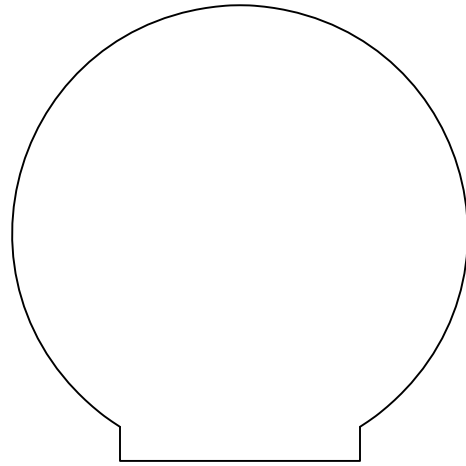

RAILO12

2 3/8" x 2 3/8"

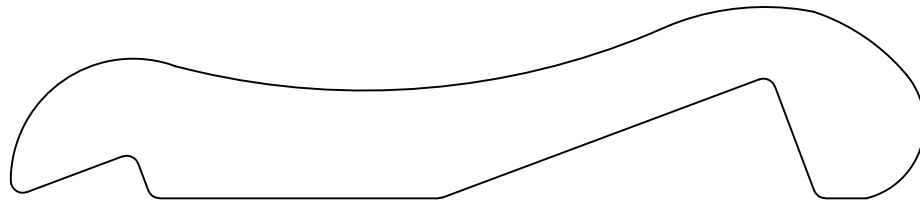

RAILO14

1" x 4 3/4"

F08

325 East Drive - Melbourne, FL 32904  
321-308-3297 - Fax 321-308-3299

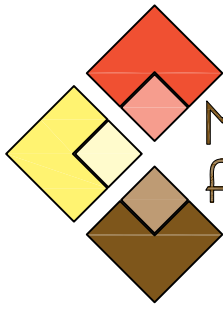

Melbourne  
Architectural  
MILLWORK COMPANY

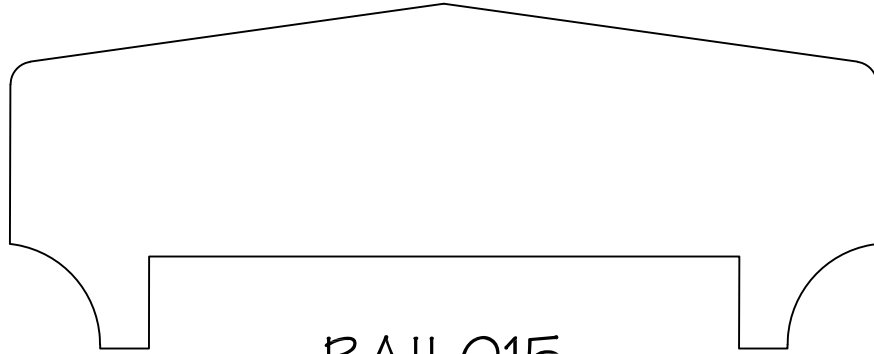

RAILO15

1 13/16" x 4 1/2"

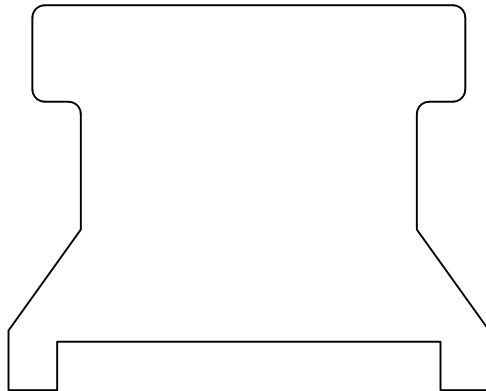

RAILO16

2" x 2 1/2"